

# DKM-409 PRO AT

## NETWORK ANALYSER

### DESCRIPTION

The DKM-409-Pro-At is a precision instrument designed for displaying, logging and remote monitoring various AC parameters in a 3-phase network.

The power supply of the unit is isolated. The standard supply range is 100-265V-AC and 88-400V-DC allowing universal use in AC and DC systems.

The unit has 3 x 4-20mA analog outputs. Any measurement can be output as analog value.

The unit has 4 digital inputs and 2 relay outputs with programmable functionality, selected from a list.

Thanks to its isolated RS-485 Modbus RTU comport, the device is free from ground potential difference issues and data are safely transferred to automation and monitoring systems.

The device has 1MB internal memory for the record of all electrical parameters with required frequency. Records are read through Modbus.

The graphic screen allows display of waveforms and harmonic analysis graphs.

The user configurable screen where any measured parameter set can be displayed, transforms the unit to a custom designed measurement panel.

### MEASUREMENTS

Ph-N and Ph-Ph volts: V1-V2-V3-U12-U23-U31

Phase and neutral currents: I1-I2-I3-In

Phase and total, active/reactive/apparent powers:

P1-P2-P3-Q1-Q2-Q3-S1-S2-S3-ΣP-ΣQ-ΣS

Ph and total power factor: pf1-pf2-pf3-Σpf

Active and reactive counters: Pimp1-Pexp1-Qcap1-Qind1, Pimp2-Pexp2-Qcap2-Qind2

User counters: USR1-USR2-USR3-USR4

2...49 Harmonics of any voltage or current

### FEATURES

**True RMS measurements**

**0.5% measurement accuracy**

**DC supply version available**

**Internal 1MB record memory (optional 16MB)**

**Harmonic distortion display (49 harmonics)**

**Oscilloscope, waveform display**

**Max demand display**

**User configurable display screen**

**Fully isolated RS-485 serial port**

**MODBUS-RTU communication**

**2 configurable relay outputs**

**Energy pulse output capability**

**4 optically isolated, configurable digital inputs**

**3 isolated, programmable 4-20mA analog out**

**Switched dual active-reactive power counters**

**Independent mains/generator energy metering**

**Configurable user counters**

**Voltage transformer ratio for MV applications**

**Password protected front panel programming**

**Free configuration program**

**Mini-USB port for programming**

**High visibility, 128x64 pixels graphic LCD**

**Reduced panel depth**

**Wide supply range 100-265VAC / 88-400VDC**

**Wide operating temperature range**

**Sealed front panel (IP54)**

**Plug-in connection system**



## COPYRIGHT NOTICE

Any unauthorized use or copying of the contents or any part of this document is prohibited.

## ABOUT THIS DOCUMENT

This document describes minimum requirements and necessary steps for the successful installation of the DKM-409-PRO-AT family units.

Follow carefully advices given in the document. These are often good practices for the installation which reduce future issues.

For all technical queries please contact Datakom at below e-mail address:

**datakom@datakom.com.tr**

## QUERRIES

If additional information to this manual is required, please contact the manufacturer directly at below e-mail address:

**datakom@datakom.com.tr**

Please provide following information in order to get answers to any question:

- Device model name (see the back panel of the unit),
- Complete serial number (see the back panel of the unit),
- Firmware version (read from the display screen),
- Measuring-circuit voltage and power supply voltage,
- Precise description of the query.

## REVISION HISTORY

REVISION	DATE	AUTHOR	DESCRIPTION
01	22.02.2016	TO	First edition

## RELATED DOCUMENTS

FILENAME	DESCRIPTION
Rainbow Plus Installation	Rainbow Plus Installation Guide
Rainbow Plus Usage	Rainbow Plus Usage Guide

## TERMINOLOGY



**CAUTION:** Potential risk of injury or death.



**WARNING:** Potential risk of malfunction or material damage.



**ATTENTION:** Useful hints for the understanding of device operation.

## ORDERING CODES

The DKM family units are available in various options and peripheral features. Please use below information for ordering the correct version:

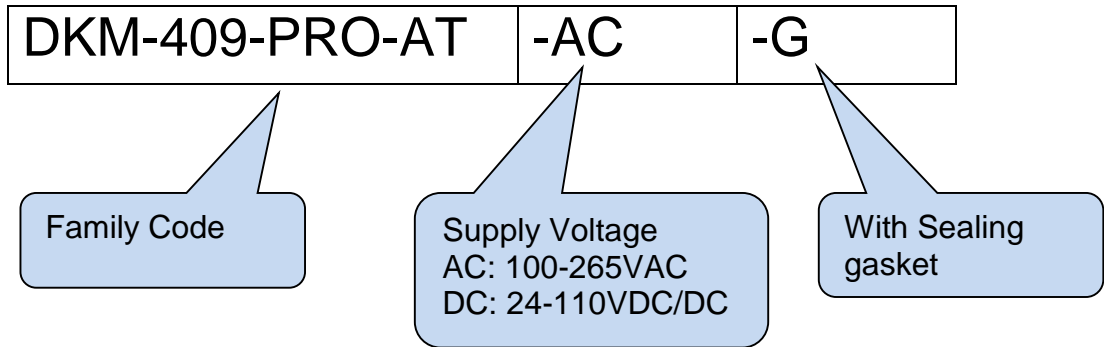

## SPARE PARTS



Screw type bracket  
Stock Code=J10P01 (per unit)



Self Retaining type bracket  
Stock Code=K16P01 (per unit)



Sealing Gasket, Stock Code= K46P01

**SAFETY NOTICE**

Failure to follow below instructions will result in death or serious injury



- Electrical equipment should be installed only by qualified specialist. No responsibility is assured by the manufacturer or any of its subsidiaries for any consequences resulting from the non-compliance to these instructions.

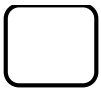

- Check the unit for cracks and damages due to transportation. Do not install damaged equipment.



- Do not open the unit. There are no serviceable parts inside.



- Fuses must be connected to the power supply and phase voltage inputs, in close proximity of the unit.



- Fuses must be of fast type (FF) with a maximum rating of 6A.



- Disconnect all power before working on equipment.



- When the unit is connected to the network do not touch terminals.



- Short circuit terminals of unused current transformers.



- Any electrical parameter applied to the device must be in the range specified in the user manual. Although the unit is designed with a wide safety margin, over-range parameters may reduce lifetime, alter operational precision or even damage the unit.



- Do not try to clean the device with solvent or the like. Only clean with a damp cloth.



- Verify correct terminal connections before applying power.

- Only for front panel mounting.



Current Transformers must be used for current measurement. No direct connection allowed.

## TABLE OF CONTENTS

- 1. INSTALLATION INSTRUCTIONS**
- 2. MOUNTING**
  - 2.1. DIMENSIONS**
  - 2.2. MECHANICAL INSTALLATION**
  - 2.3. SEALING, GASKET**
  - 2.4. ELECTRICAL INSTALLATION**
- 3. TERMINAL DESCRIPTIONS**
  - 3.1. AUXILIARY SUPPLY INPUT**
  - 3.2. AC VOLTAGE INPUTS**
  - 3.3. AC CURRENT INPUTS**
  - 3.4. DIGITAL INPUTS**
  - 3.5. RELAY OUTPUTS**
  - 3.6. RS-485 PORT**
  - 3.7. USB PORT**
- 4. TOPOLOGIES**
  - 4.1. SELECTING THE TOPOLOGY**
  - 4.2. 3 PHASE, 4 WIRE STAR**
  - 4.3. 3 PHASE, 3 WIRE DELTA**
  - 4.4. 3 PHASE, 4 WIRE DELTA**
  - 4.5. 3 PHASE, 3 WIRE, DELTA, 2 CT (L1-L2)**
  - 4.6. 3 PHASE, 3 WIRE, DELTA, 2 CT (L1-L3)**
  - 4.7. 2 PHASE, 3 WIRE, DELTA, 2 CT (L1-L2)**
  - 4.8. 1 PHASE, 2 WIRE**
- 5. CONNECTION DIAGRAM**
- 6. TECHNICAL SPECIFICATIONS**
- 7. TERMINAL DESCRIPTION**
- 8. DESCRIPTION OF CONTROLS**
  - 8.1. FRONT PANEL FUNCTIONALITY**
  - 8.2. PUSHBUTTON FUNCTIONS**
  - 8.3. MEASURED PARAMETERS**
- 9. INDICATOR SYMBOLS**
  - 9.1. SCREEN SCROLLING**
- 10. WAVEFORM DISPLAY & HARMONIC ANALYSIS**
- 11. ASTRONOMIC RELAY FUNCTIONALITY**
- 12. USER CONFIGURABLE DISPLAY SCREENS**
- 13. POWER COUNTERS & INCREMENTAL COUNTERS**
- 14. DEMAND VALUES**
- 15. MIN-MAX VALUES**
- 16. DISPLAYING EVENT LOGS**

**17. PROTECTIONS AND ALARMS****18. PROGRAMMING****18.1. ENTERING THE PROGRAMMING MODE****18.2. NAVIGATING BETWEEN MENUS****18.3. MODIFYING PARAMETER VALUE****18.4. PROGRAMMING MODE EXIT****19. PROGRAM PARAMETER LIST****19.1. CONTROLLER CONFIGURATION GROUP****19.2. ELECTRICAL PARAMETERS GROUP****19.3. INPUT PARAMETERS****19.4. OUTPUT PARAMETERS****19.5. ANALOGUE OUTPUTS****19.6. USER INPUT STRINGS****19.7. MIN/MAX/COUNTER SET****19.8. USER SCREENS****19.9. DEVICE SERIAL NUMBER****19.10. CALIBRATION PARAMETERS****19.11. ADJUST DATE AND TIME****19.12. CHANGE PASSWORD****19.13. RETURN TO FACTORY SETTINGS****19.14. LOCATION SETUP****20. INTERNAL RECORD MEMORY****21. MODBUS COMMUNICATIONS****21.1. PARAMETERS REQUIRED FOR RS-485 MODBUS OPERATION****21.2. DATA FORMATS****21.3. DATA READ****21.4. DATA WRITE****21.5. CRC CALCULATION****21.6. INTERNAL RECORD MEMORY STRUCTURE****21.7. COMMANDS****21.8. REAL TIME CLOCK****21.9. COUNTERS****21.10. MEASUREMENTS****21.11. ALARM FUNCTION BITS****21.12. HARMONIC MEASUREMENT****21.13. DEMAND-MIN-MAX****22. DECLARATION OF CONFORMITY****23. MAINTENANCE****24. DISPOSAL OF THE UNIT****25. ROHS COMPLIANCE****26. TROUBLESHOOTING GUIDE**

## 1. INSTALLATION INSTRUCTIONS

### **Before installation:**

- Read the user manual carefully, determine the correct connection diagram.
- Remove all connectors and mounting brackets from the unit, then pass the unit through the mounting opening.
- Put mounting brackets and tighten. Do not tighten too much, this can damage the enclosure.
- Make electrical connections with plugs removed from sockets, then place plugs to their sockets.
- Be sure that adequate cooling is provided.
- Be sure that the temperature of the environment will not exceed the maximum operating temperature in any case.
- Be sure that the unit is not subject to water spill.

### **Below conditions may damage the device:**

- Incorrect connections.
- Incorrect power supply voltage.
- Voltage at measuring terminals beyond specified range.
- Voltage applied to digital inputs over specified range.
- Current at measuring terminals beyond specified range.
- Overload or short circuit at relay outputs
- Connecting or removing data terminals when the unit is powered-up.
- High voltage applied to communication ports.
- Ground potential differences at non-isolated communication ports.
- Excessive vibration, direct installation on vibrating parts.



**Current Transformers must be used for current measurement.  
No direct connection allowed.**

### **Below conditions may cause abnormal operation:**

- Power supply voltage below minimum acceptable level.
- Power supply frequency out of specified limits
- Phase order of voltage inputs not correct.
- Current transformers not matching related phases.
- Current transformer polarity incorrect.



## 2. MOUNTING

### 2.1. DIMENSIONS

**Dimensions:** 102x102x53mm (4.0"x4.0"x2.0")

**Installation:** Flush mounting with rear brackets

**Weight:** 200g (0.44 lb)

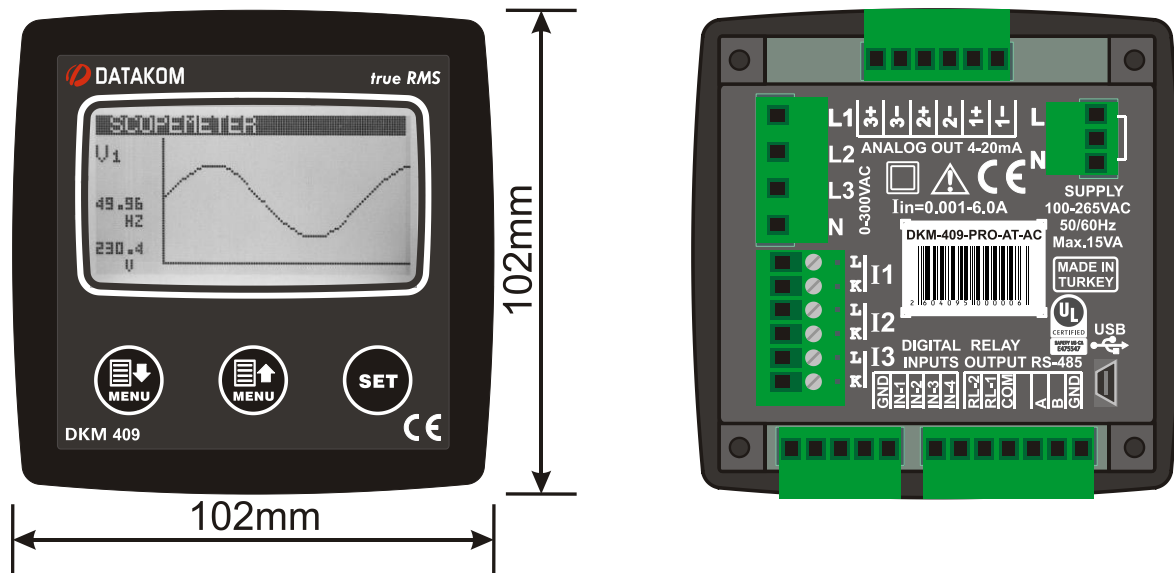

### 2.2. MECHANICAL INSTALLATION

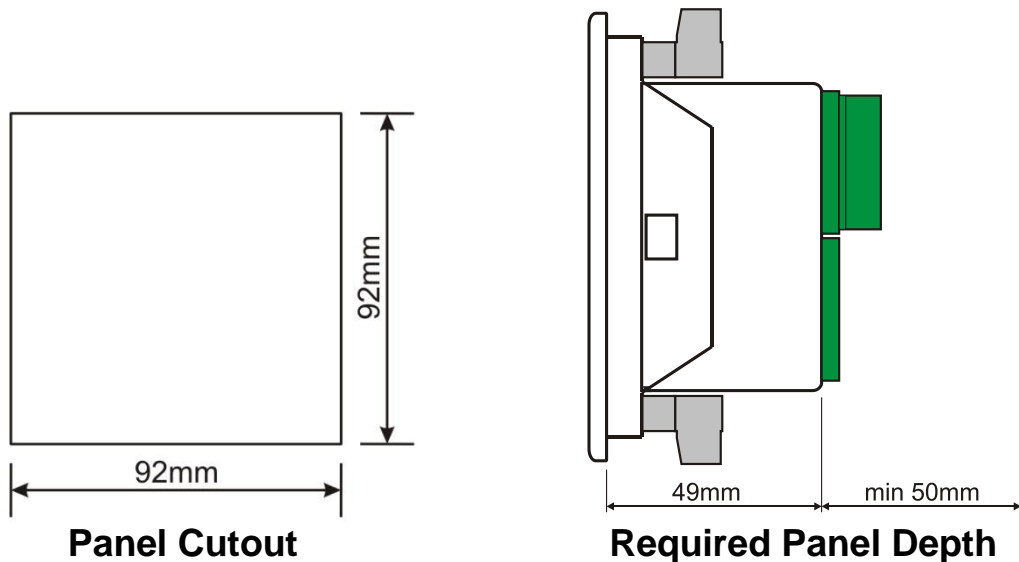

**The unit is designed for panel mounting.  
The user should not be able to access parts of the  
unit other than the front panel.**

Mount the unit on a flat, vertical surface. Before mounting, remove the mounting brackets and connectors from the unit, then pass the unit through the mounting opening. Place and tighten mounting brackets.

Two different types of brackets are provided:



Screw type bracket



Self retaining type bracket



Installation of screw type bracket

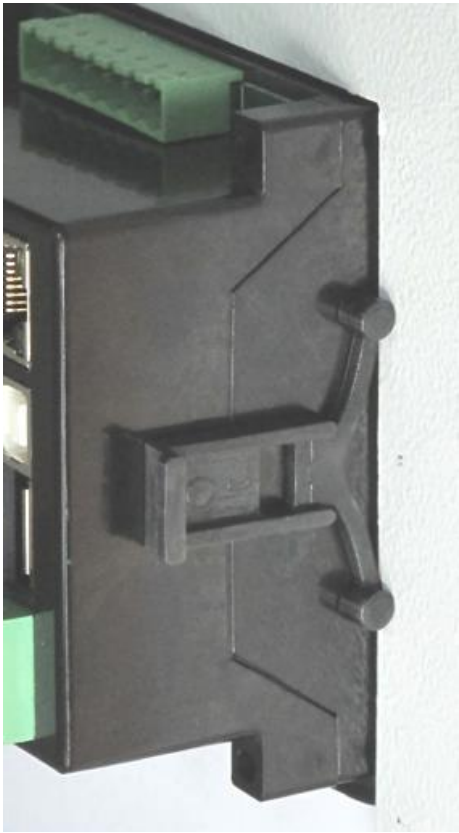

Installation of self retaining type bracket



**Do not tighten too much, this may break the unit.**

## 2.3. SEALING, GASKET

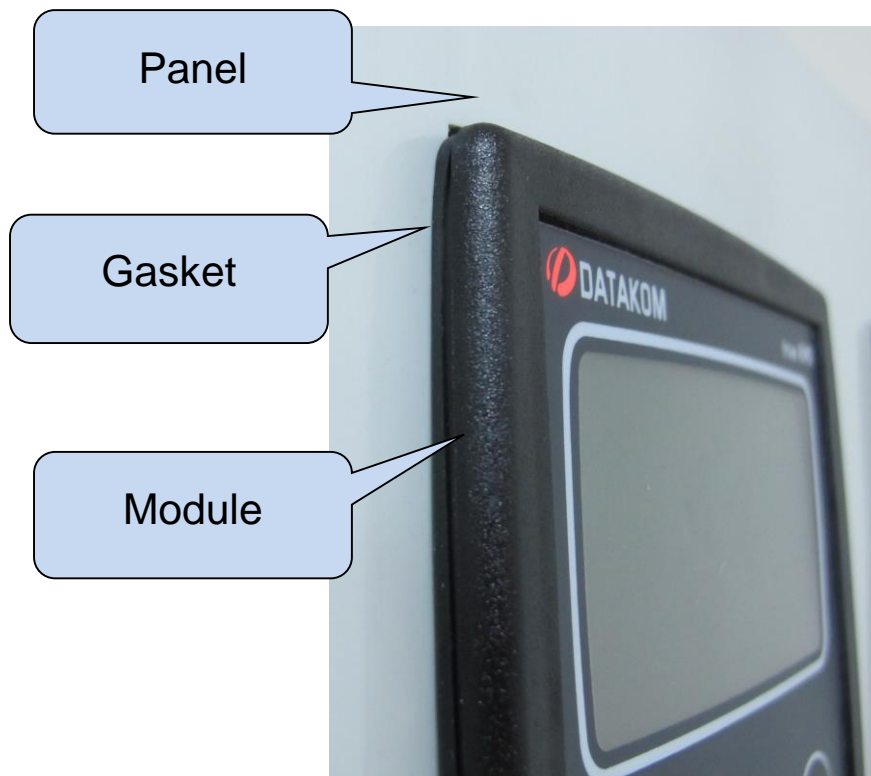

The rubber gasket (sold optionally) provides a watertight means of mounting the module to the panel. Together with the gasket, IEC 60529-IP65 protection can be reached from the front panel. A short definition of IP protection levels is given below.

### 1st Digit

- 0 Not protected
- 1 Protected against solid foreign objects of 50 mm diameter and greater
- 2 Protected against solid foreign objects of 12,5 mm diameter and greater
- 3 Protected against solid foreign objects of 2,5 mm diameter and greater
- 4 Protected against solid foreign objects of 1,0 mm diameter and greater
- 5 Protected from the amount of dust that would interfere with normal operation
- 6 Dust tight**

### 2nd Digit

- 0 Not protected
- 1 Protected against vertically falling water drops
- 2 Protected against vertically falling water drops when enclosure is tilted up to 15 °
- 3 Protected against water sprayed at an angle up to 60 ° on either side of the vertical
- 4 Protected against water splashed against the component from any direction
- 5 Protected against water projected in jets from any direction**
- 6 Protected against water projected in powerful jets from any direction
- 7 Protected against temporary immersion in water
- 8 Protected against continuous immersion in water, or as specified by the user

## 2.4. ELECTRICAL INSTALLATION



**Do not install the unit close to high electromagnetic noise emitting devices like contactors, high current busbars, switchmode power supplies and the like.**

Although the unit is protected against electromagnetic disturbance, excessive disturbance can affect the operation, measurement precision and data communication quality.

- **ALWAYS** remove plug connectors when inserting wires with a screwdriver.
- Fuses must be connected to the power supply and phase voltage inputs, in close proximity of the unit.
- Fuses must be of fast type (C) with a maximum rating of 6A.
- Use cables of appropriate temperature range.
- Use adequate cable section, at least 0.75mm<sup>2</sup> (AWG18).
- Follow national rules for electrical installation.
- Current transformers must have 5A output.
- For current transformer inputs, use at least 1.5mm<sup>2</sup> section (AWG15) cable.
- The current transformer cable length should not exceed 1.5 meters. If longer cable is used, increase the cable section proportionally.



**Current Transformers must be used for current measurement.**

**No direct connection allowed.**



**For the correct recording of events, adjust the real time clock of the unit through programming menu.**

### 3. TERMINAL DESCRIPTIONS

#### 3.1. AUXILIARY SUPPLY INPUT

<b>Supply voltage operating limits:</b>	<b>STANDARD AC SUPPLY VERSIONS:</b> 100-265VAC( $\pm\%15$ ), 50-60Hz ( $\pm\%10$ ), 88-400VDC <b>OPTIONAL DC SUPPLY VERSIONS:</b> 19-150VDC
<b>Reverse voltage:</b>	Non polarized inputs, works in both polarizations.
<b>Maximum input power:</b>	15 VA
<b>Isolation</b>	3500VAC/1minute from all other terminals.

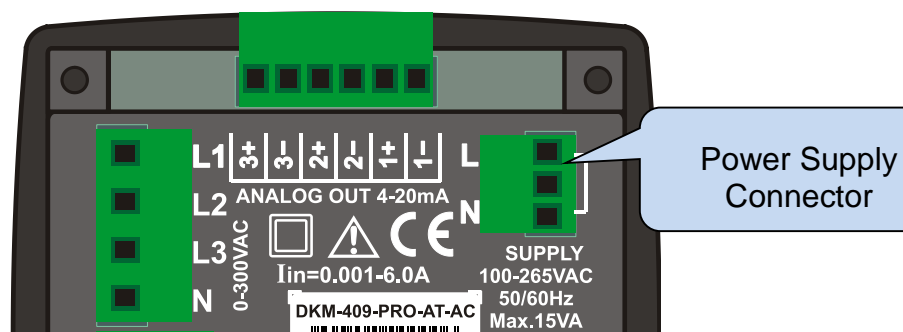

The connection cables for the power supply voltage must be fused with a UL listed fuse (6A type C).

#### 3.2. AC VOLTAGE INPUTS

<b>Measurement method:</b>	True RMS
<b>Sampling rate:</b>	8192 samples/sec.
<b>Harmonic analysis:</b>	up to 49th harmonic
<b>Input voltage range:</b>	0 to 300 VAC (phase-neutral)
<b>Measurement range:</b>	7 to 330VAC ph-N (14 to 520VAC ph-ph)
<b>Input impedance:</b>	4.5M-ohms
<b>Display resolution:</b>	0.1VAC
<b>Accuracy:</b>	0.5% + 1 digit @ 230VAC ph-N ( $\pm 2$ VAC ph-N) 0.5% + 1 digit @ 400VAC ph-ph ( $\pm 3$ VAC ph-ph)
<b>Withstanding:</b>	1300V-AC continuous

<b>Frequency range:</b>	30 to 100 Hz
<b>Frequency display resolution:</b>	0.01 Hz
<b>Frequency accuracy:</b>	0.5% + 1 digit

### 3.3. AC CURRENT INPUTS

<b>Structure:</b>	Isolated, internal current transformers
<b>Measurement method:</b>	True RMS
<b>Sampling rate:</b>	8192 samples/sec.
<b>Harmonic analysis:</b>	up to 49th harmonic
<b>CT secondary rating:</b>	5A
<b>Measurement range:</b>	5/5 - 25000/5A minimum
<b>Input impedance:</b>	15 mili-ohm
<b>Burden:</b>	0.375W
<b>Maximum current:</b>	6A continuous
<b>Measurement range:</b>	0.001 to 6A AC
<b>Display resolution:</b>	0.1A
<b>Accuracy:</b>	0.5% + 1 digit
<b>Isolation:</b>	1000VAC/1minute from all other terminals.
<b>Withstand:</b>	100A-AC for 1 second

#### **SELECTING THE CT RATING AND CABLE SECTION:**

The load on a CT should be kept minimum in order to minimize phase shift effect of the current transformer. Phase shift in a CT will cause erroneous power and power factor readings, although amp readings are correct.

Datakom advises CT rating to be selected following this table for the best measurement accuracy.

#### **SELECTING THE CT ACCURACY CLASS:**

The CT accuracy class should be selected in accordance with the required measurement precision. The accuracy class of the Datakom controller is 0.5%. Thus 0.5% class CTs are advised for the best result.

#### **CONNECTING CTs:**

Be sure of connecting each CT to the related phase input with the correct polarity. Mixing CTs between phases will cause faulty power and pf readings.

Many combinations of incorrect CTs connections are possible, so check both order of CTs and their polarity. Reactive power measurement is affected by incorrect CTs connection in similar way as active power measurement.

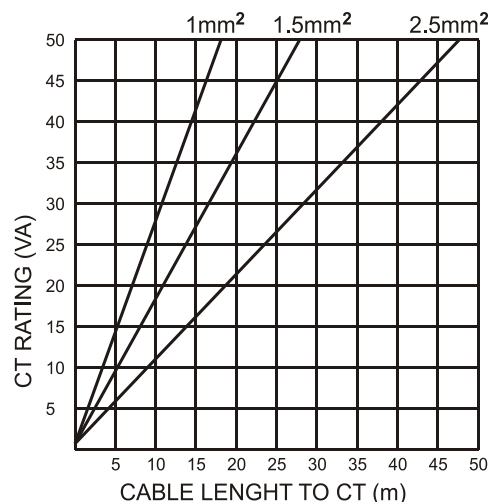

**CORRECT CT CONNECTIONS**

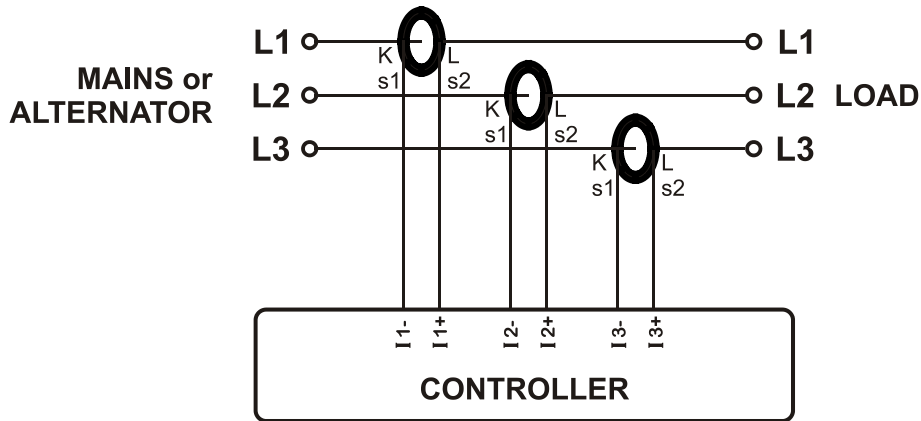

Let's suppose that the network is loaded with 100 kW on each phase. The load Power Factor (PF) is 1. Measured values are as follows:

	kW	kVAr	kVA	pf
Phase L1	100.0	0.0	100	1.00
Phase L2	100.0	0.0	100	1.00
Phase L3	100.0	0.0	100	1.00
<b>Total</b>	<b>300.0</b>	<b>0.0</b>	<b>300</b>	<b>1.00</b>

**EFFECT OF POLARITY REVERSAL**

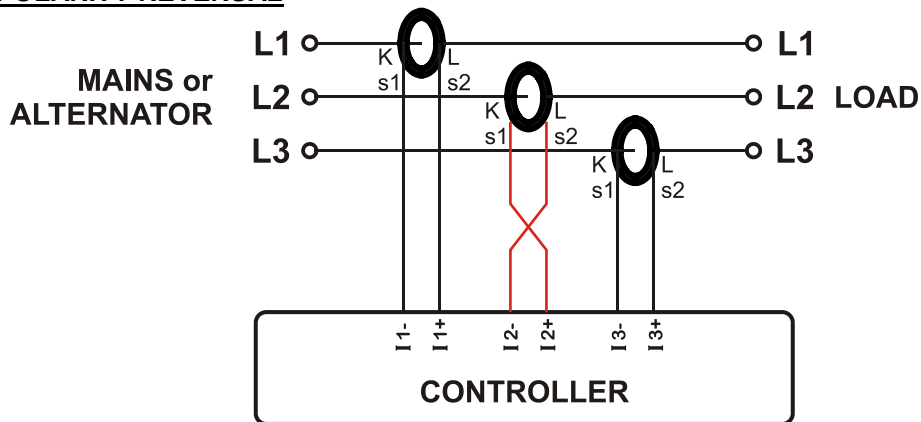

The network is still loaded with 100 kW On each phase. The load Power Factor (PF) is 1. PF in phase L2 will show -1,00 due to reverse CT polarity. The result is that total network power displayed by the controller is 100 kW. Measured values are as follows:

	kW	kVAr	kVA	pf
Phase L1	100.0	0.0	100	1.00
Phase L2	-100.0	0.0	100	-1.00
Phase L3	100.0	0.0	100	1.00
<b>Total</b>	<b>100.0</b>	<b>0.0</b>	<b>300</b>	<b>0.33</b>

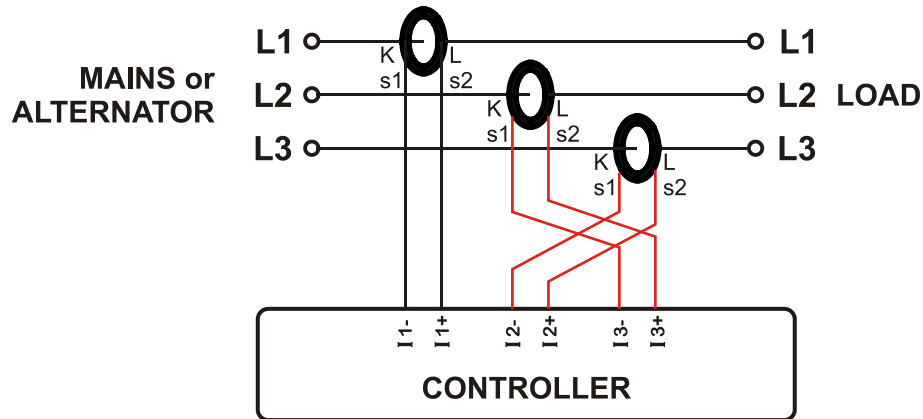
**EFFECT OF PHASE SWAPPING**

The network is still loaded with 100 kW on each phase. The load Power Factor (PF) is 1. PF in phases L2 and L3 will show -0,50 due to phase shift between voltages and currents which is caused by CT swapping. The result is that total network power displayed by controller is 0 kW. Measured values are as follows:

	<b>kW</b>	<b>kVAr</b>	<b>kVA</b>	<b>pf</b>
<b>Phase L1</b>	100.0	0.0	100	1.00
<b>Phase L2</b>	-50.0	86.6	100	-0.50
<b>Phase L3</b>	-50.0	-86.6	100	-0.50
<b>Total</b>	<b>0.0</b>	<b>0.0</b>	<b>300</b>	<b>0.0</b>

### 3.4. DIGITAL INPUTS

<b>Number of inputs:</b>	4 inputs, all configurable
<b>Input type:</b>	Opto-isolated digital input
<b>Function selection:</b>	From list
<b>Contact type:</b>	Normally open or normally closed (programmable)
<b>Minimum pulse duration:</b>	250ms
<b>Active level:</b>	40-135V-DC or 30-265V-AC
<b>Isolation:</b>	1000VAC, 1 minute
<b>Noise filtering:</b>	Yes



### 3.5. RELAY OUTPUTS

<b>Structure:</b>	Relay output, normally open, free contact output
<b>Max switching current:</b>	5A @250VAC
<b>Max switching voltage:</b>	250VAC
<b>Max switching power:</b>	1250VA

### 3.6. RS-485 PORT

<b>Structure:</b>	RS-485, isolated.
<b>Connection:</b>	3 wires (A-B-GND). Half duplex.
<b>Baud rate:</b>	2400-115200 bauds, selectable
<b>Data type:</b>	8 bit data, no parity, 1 bit stop
<b>Termination:</b>	External 120 ohms required
<b>Common mode voltage:</b>	-0.5 VDC to +7VDC, internally clamped by transient suppressors.
<b>Max distance:</b>	1200m @ 9600 bauds (with 120 ohms balanced cable) 200m @ 115200 bauds (with 120 ohms balanced cable)
<b>Isolation:</b>	500VAC, 1 minute

The RS-485 port features MODBUS-RTU protocol. Multiple modules (up to 128) can be paralleled on the same RS-485 bus for data transfer to automation or building management systems.



**The Modbus register list is available at the MODBUS section of this manual.**

The RS-485 port provides also a good solution for distant PC connection where RainbowPlus program will enable programming, control and monitoring.

#### RS-485 BUS STRUCTURE

A maximum of 32 devices can be paralleled on a RS-485 bus. For more devices on one bus, repeaters must be used.

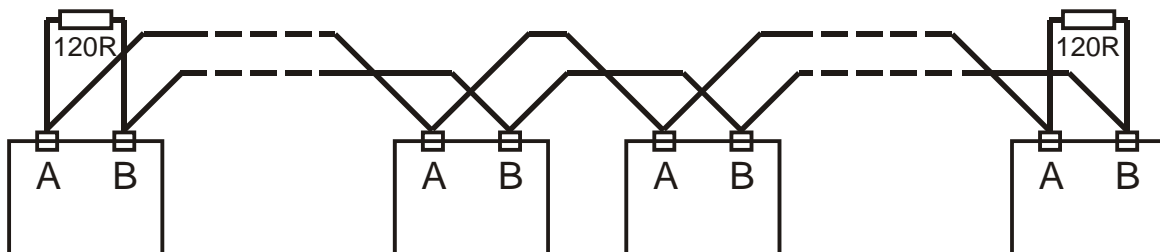

The bus must be terminated from both ends with 120 ohm resistor.

The cable shield should be grounded from one end only.



**The device does not have any internal terminating resistors. External 120 ohm resistor should be added to both extremities of the bus line.**

### 3.7. USB PORT

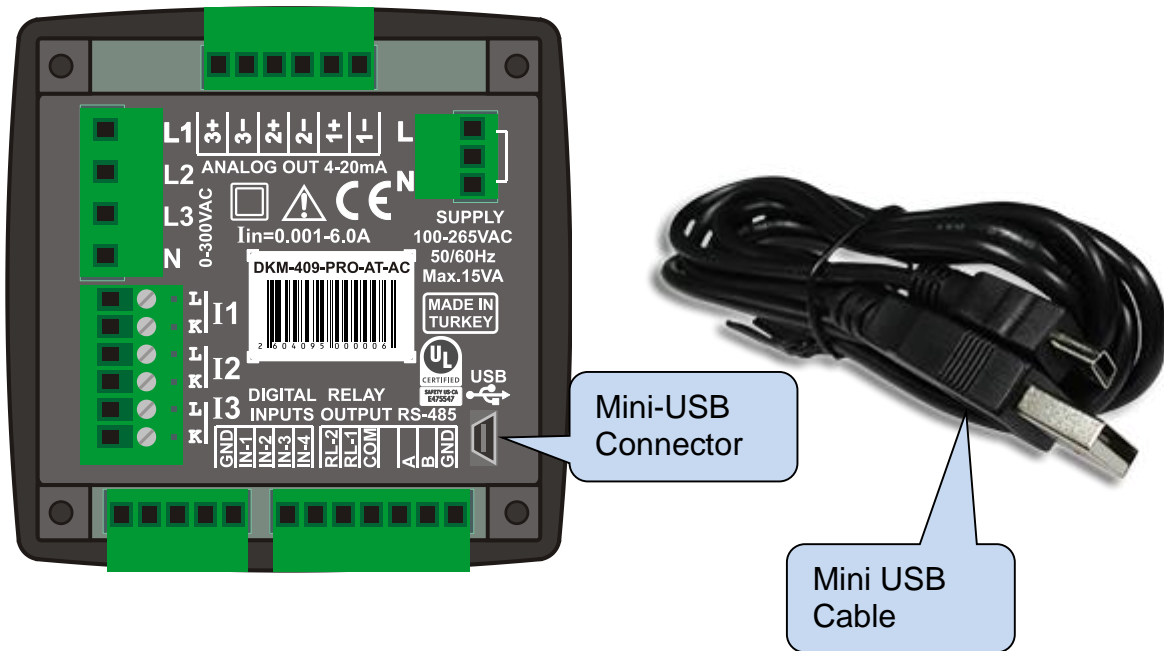

<b>Description:</b>	USB 2.0, not isolated, HID mode
<b>Data rate:</b>	Full Speed 1.5/12 Mbits/s, auto detecting
<b>Connector:</b>	Mini-USB
<b>Cable length:</b>	Max 6m
<b>Functionality:</b>	Modbus RTU

The USB-Device port is designed to connect the module to a PC. Using the RainbowPlus software, programming and monitoring of measured parameters are achieved.

The RainbowPlus software can be downloaded from [www.datakom.com.tr](http://www.datakom.com.tr) website.

The connector on the module is of Mini-USB type. Thus Mini-USB cable should be used. This is the same cable used for digital cameras.

For more details about programming, control and monitoring please refer to RainbowPlus user manual.

## 4. TOPOLOGIES

Various topologies are selectable through program parameter.

In following drawings the connections are shown for the alternator. Current transformers are supposed connected to the alternator side.

Similar topologies re available for the mains side as well.

### 4.1. SELECTING THE TOPOLOGY

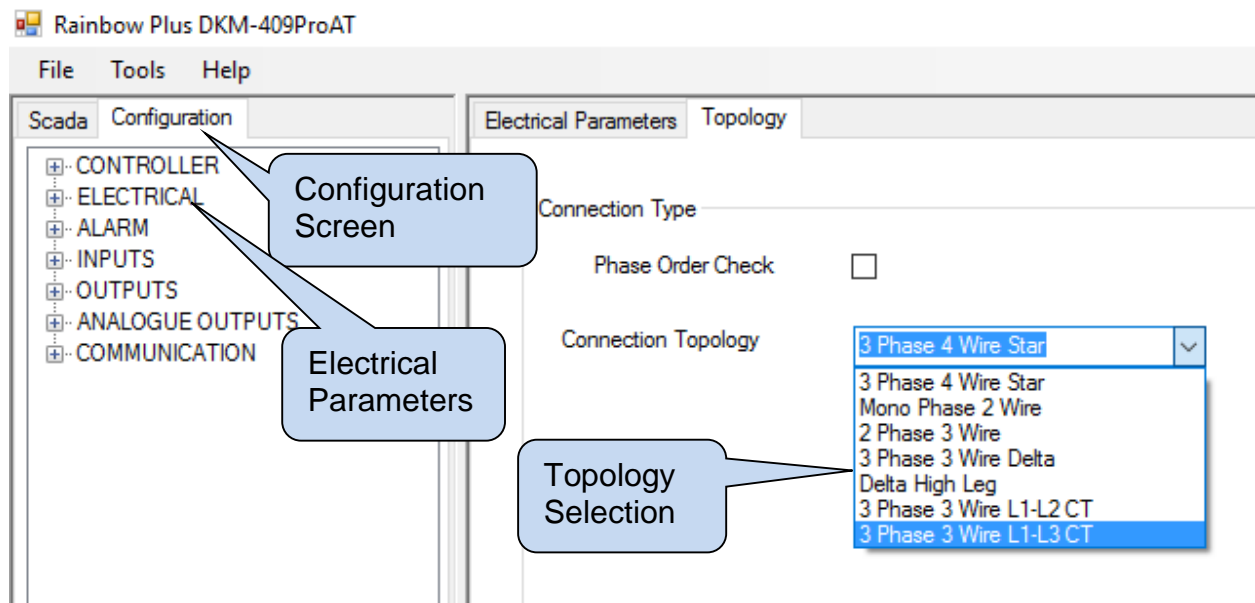

4.2. 3 PHASE, 4 WIRE, STAR

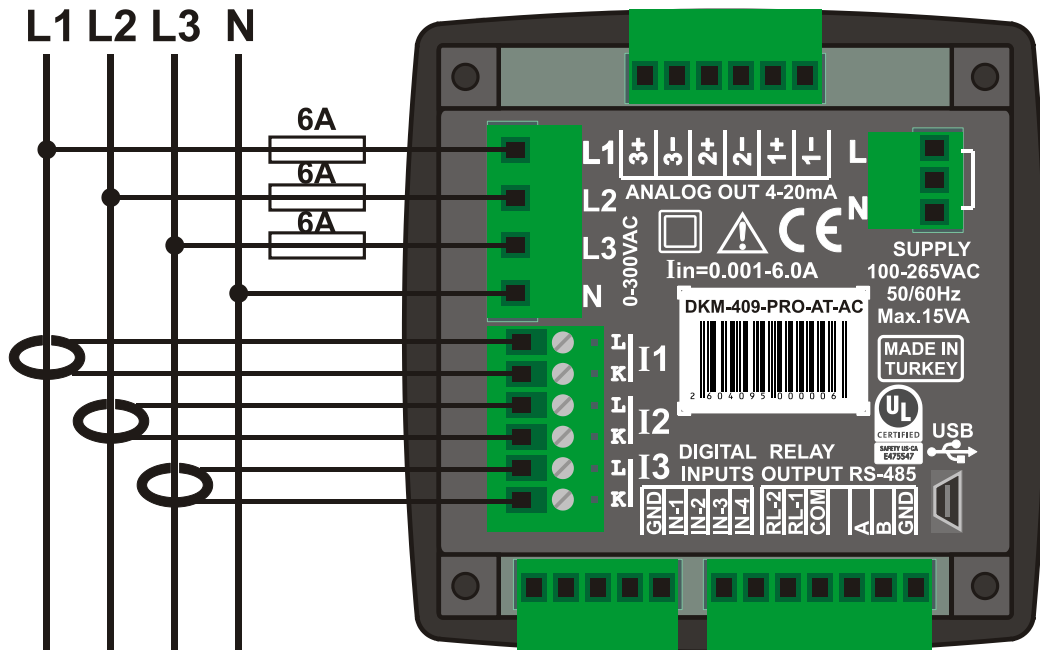

4.3. 3 PHASE, 3 WIRE, DELTA

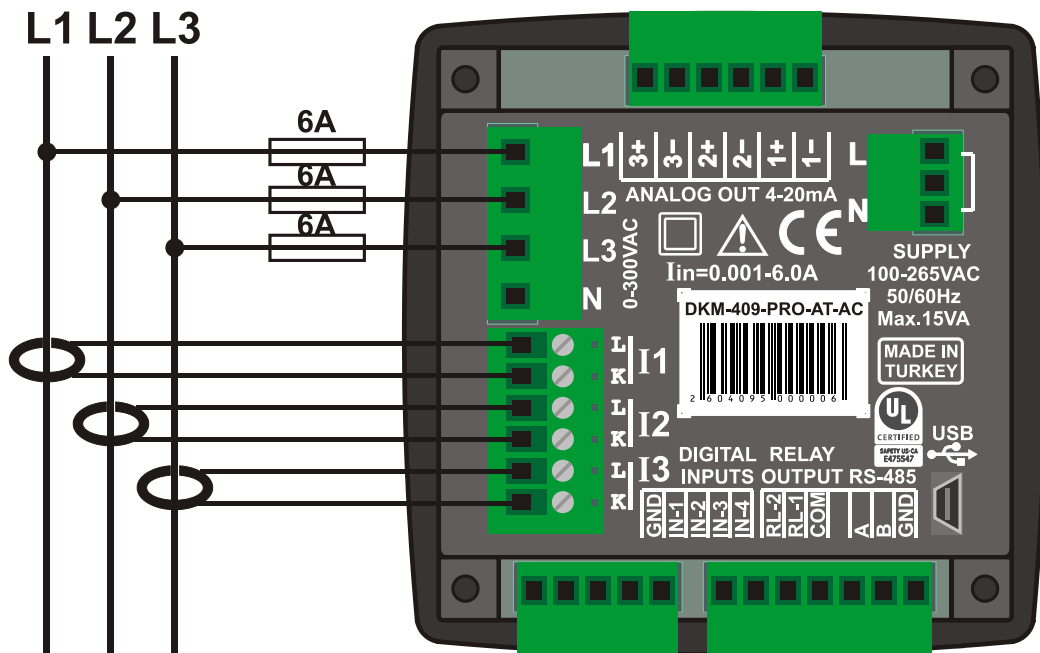

**4.4. 3 PHASE, 4 WIRE, DELTA**

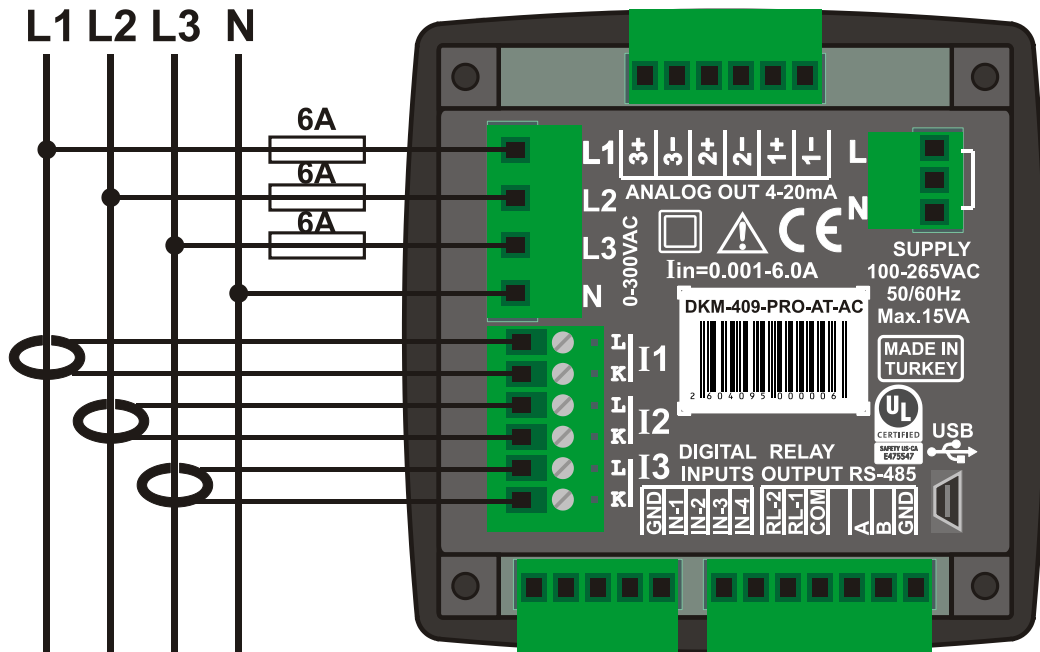

**4.5. 3 PHASE, 3 WIRE, DELTA, 2 CT (L1-L2)**

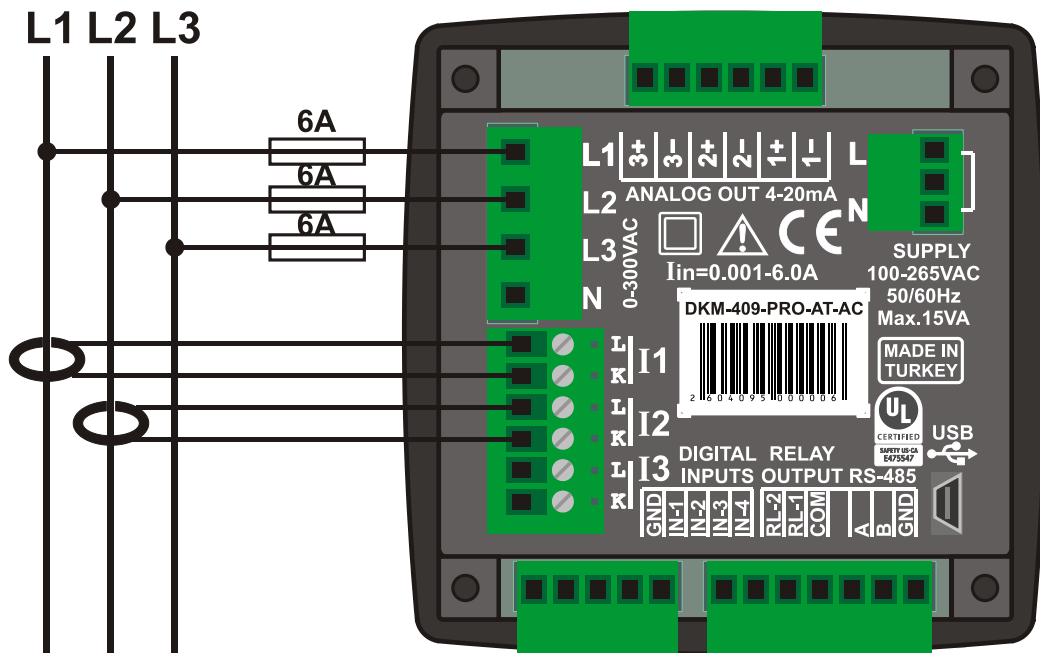

**4.6. 3 PHASE, 3 WIRE, DELTA, 2 CT (L1-L3)**

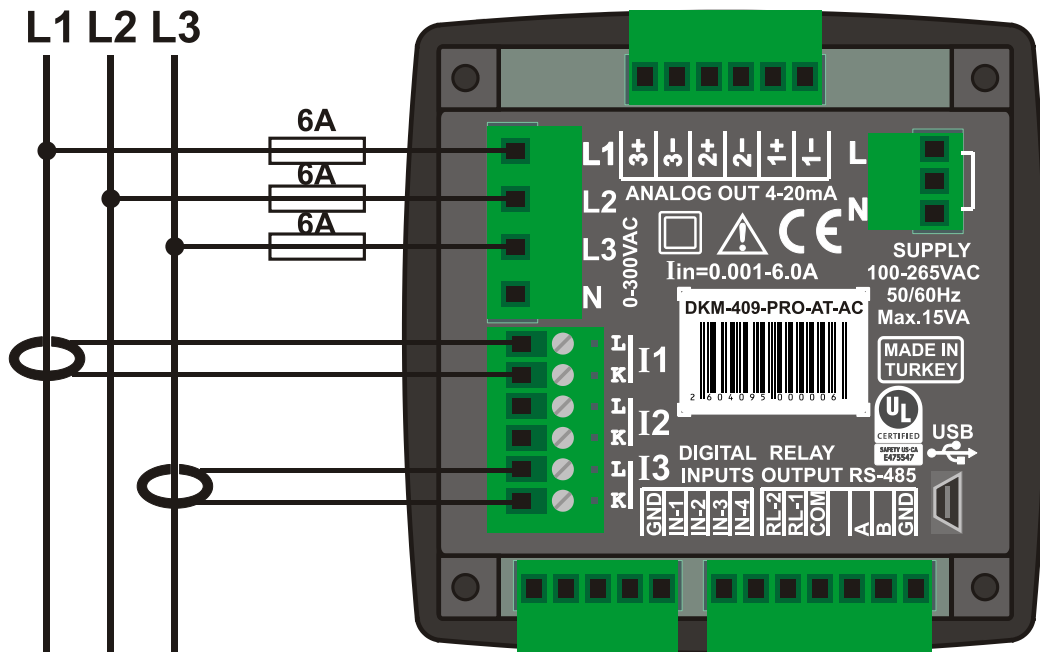

**4.7. 2 PHASE, 3 WIRE, DELTA, 2 CTs (L1-L2)**

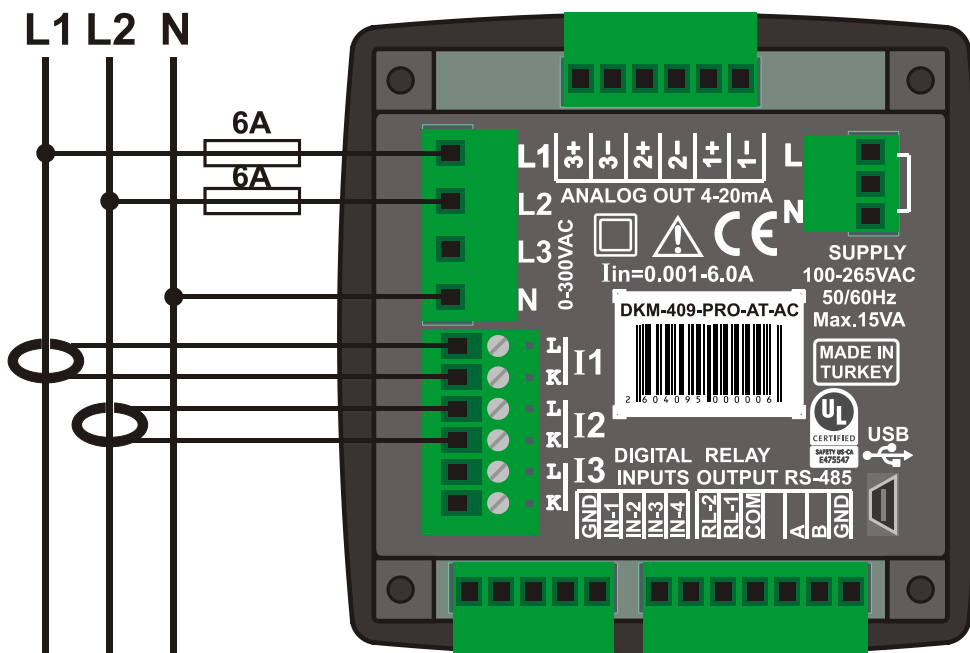

4.8. 1 PHASE, 2 WIRE

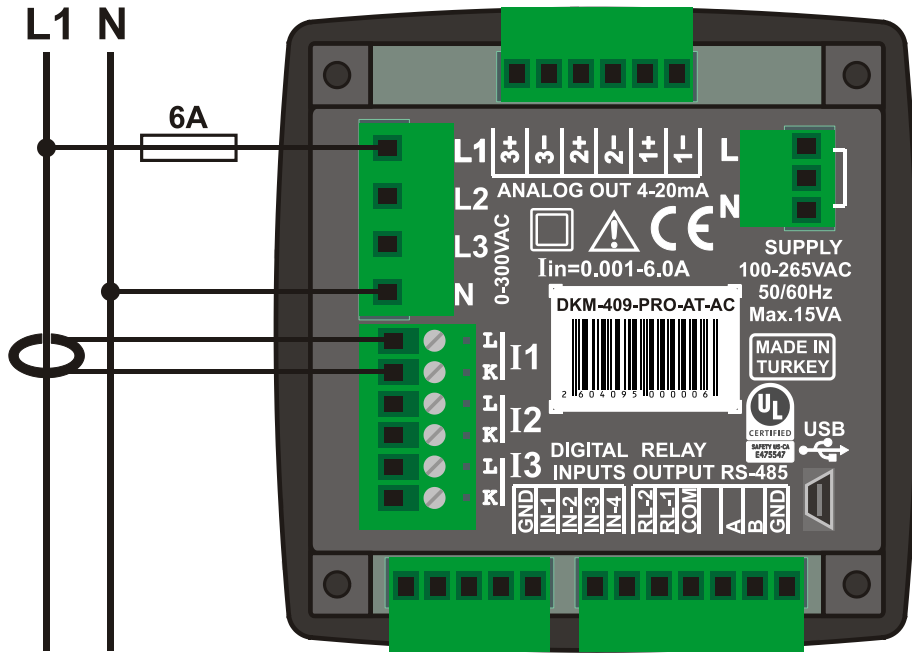

**5. CONNECTION DIAGRAM**

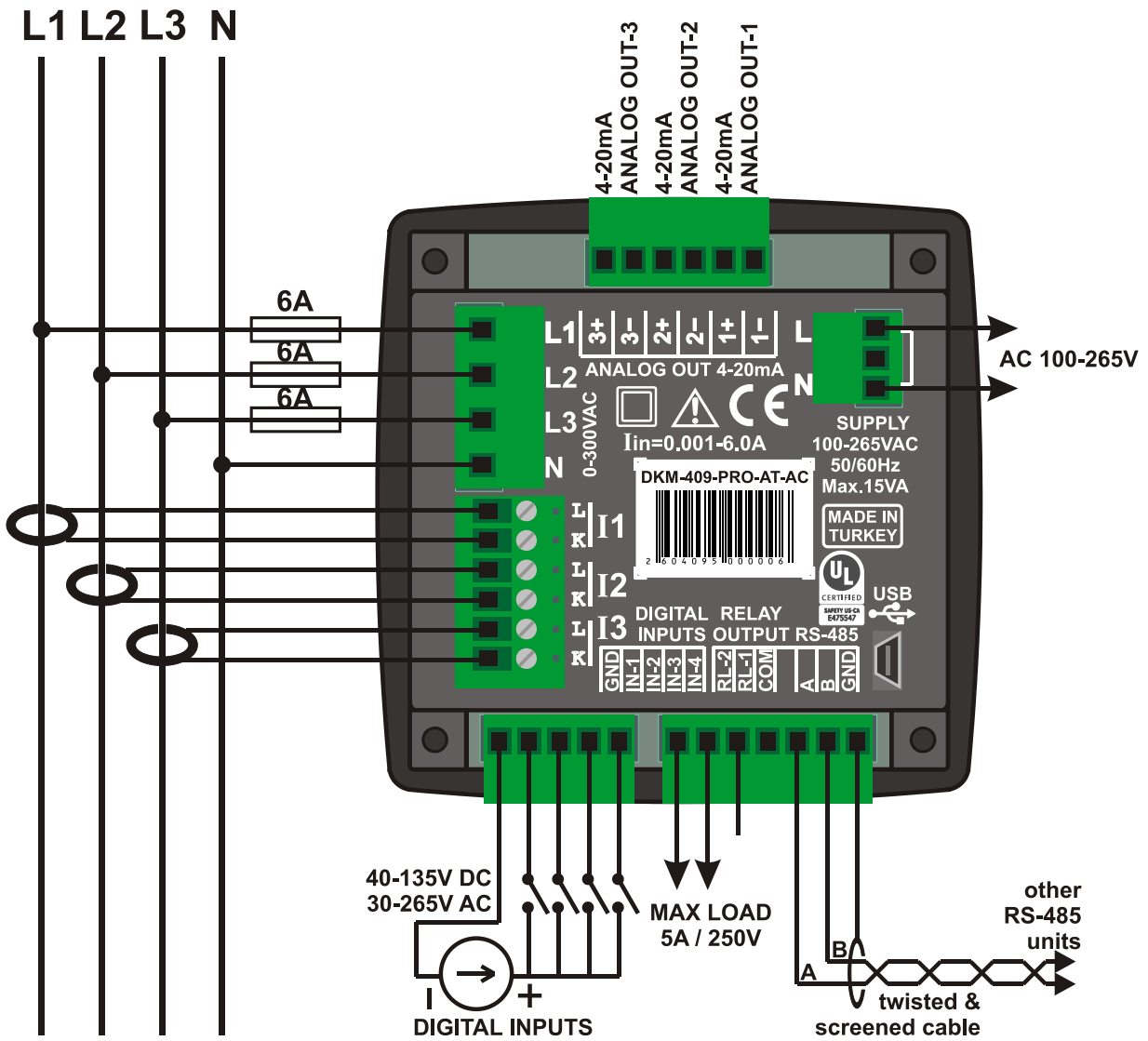



## 6. TECHNICAL SPECIFICATIONS

<b>Supply Input:</b>	100-265V AC ( $\pm 15\%$ ), 50/60Hz ( $\pm 10\%$ ), 88-400V DC
<b>Measurement Inputs:</b>	
<b>Voltage:</b>	7 - 300 V AC (P-N) 14 - 520 V AC (P-P)
<b>Current:</b>	0.001 – 6.00 A AC
<b>Frequency:</b>	30 - 100 Hz
<b>Accuracy:</b>	
<b>Voltage:</b>	0.5% + 1 digit
<b>Current:</b>	0.5% + 1 digit
<b>Frequency:</b>	0.5% + 1 digit
<b>Power (kW,kVAr):</b>	1.0% + 2 digit
<b>Cos:</b>	0.5% + 1 digit
<b>Withstanding:</b>	
<b>Current:</b>	100 A AC during 1 sec.
<b>Voltage:</b>	1300 V AC (continuous)
<b>Analog Outputs:</b>	Active 4-20mA
<b>Precision:</b>	16 bit
<b>Measurement Range:</b>	
<b>CT range:</b>	5/5A to 25000/5A
<b>VT range:</b>	0.1/1 to 5000.0/1
<b>kW range:</b>	1.0 kW to 5000 MW
<b>Power Consumption:</b>	< 15 VA
<b>Voltage Burden:</b>	< 0.02VA per phase
<b>Current Burden:</b>	< 0.5VA per phase
<b>Relay Outputs:</b>	5A @ 250V AC
<b>Digital Inputs:</b>	
<b>Active level:</b>	40 to 135V DC or 30 to 265V AC
<b>Min pulse:</b>	250ms.
<b>Isolation:</b>	1000V AC, 1 minute
<b>Serial Port:</b>	
<b>Signal level:</b>	RS-485
<b>Protocol:</b>	Modbus RTU
<b>Data Rate:</b>	Adjustable 2400-115200 bauds
<b>Isolation:</b>	500V AC, 1 minute
<b>Operating Temp. Range:</b>	-20°C to +70 °C (-4°F to 158°F)
<b>Max Humidity:</b>	95%, non-condensing
<b>Degree of Protection:</b>	IP 54 (Front Panel) IP 30 (Back Panel)
<b>Enclosure:</b>	Non-flammable, ROHS compliant
<b>Installation:</b>	Flush mounting with rear brackets
<b>Dimensions:</b>	102x102x53mm (WxHxD)
<b>Panel Cutout:</b>	92x92mm
<b>Weight:</b>	200 gr
<b><u>EU Directives:</u></b>	<b><u>Norms of Reference:</u></b>
2006/95/EC (LVD)	EN 61010 (safety)
2004/108/EC (EMC)	EN 61326 (EMC)
<b><u>UL-CSA Certification:</u></b>	
UL 61010-1, 3rd Edition, 2012-05,	
CAN/CSA-C22.2	
File: E475547, Vol. D1	

## 7. TERMINAL DESCRIPTION

Term	Function	Technical data	Description
	<b>AUXILIARY SUPPLY</b>	100 to 265VAC	Aux supply terminal
	-	-	Do not connect this terminal.
	<b>AUXILIARY SUPPLY</b>	100 to 265VAC	Aux supply terminal

Term	Function	Technical data	Description
	<b>L1</b>	phase inputs, 0-300V-AC	Connect the mains phases to these inputs.
	<b>L2</b>		
	<b>L3</b>		
	<b>NEUTRAL</b>	Input, 0-300V-AC	Neutral terminal for the mains phases.

Term	Function	Technical data	Description
	<b>CURR_1_L</b>	Current transformer inputs, 5A-AC	Connect the current transformer terminals to these inputs. Connect each terminal of the transformer to the unit's related terminal. Correct polarity of connection is vital. The rating of the transformers should be identical for each of the 3 phases. The secondary winding rating shall be 5 Amperes. (ex: 200/5 Amps).
	<b>CURR_1_K</b>		
	<b>CURR_2_L</b>		
	<b>CURR_2_K</b>		
	<b>CURR_3_L</b>		
	<b>CURR_3_K</b>		

Term	Function	Technical data	Description
	<b>RS-485 A</b>	Digital communication port	Connect the A-B data lines of the RS-485 link to these terminals.
	<b>RS-485 B</b>		
	<b>PROTECTION GROUND</b>	Grounding terminal	Connect the protective shield of the RS-485 cable to this terminal.

Term	Function	Technical data	Description
	<b>DIGITAL INPUT 1</b>	Digital Inputs, 40-135V-DC or 30-265V-AC	Inputs have programmable function.
	<b>DIGITAL INPUT 2</b>		
	<b>DIGITAL INPUT 3</b>		
	<b>DIGITAL INPUT 4</b>		
	<b>DIGITAL INPUT COMMON</b>	Common terminal	Negative common terminal for digital inputs.

Term	Function	Technical data	Description
	<b>DIGITAL OUTPUT 1</b>	Relay output, 5A/250VAC	Relay output, normally open contact. Relay functions are programmable.
	<b>DIGITAL OUTPUT 2</b>	Relay output, 5A/250VAC	Relay output, normally open contact. Relay functions are programmable.
	<b>DIGITAL OUTPUT COMMON</b>	Common terminal	Common input voltage for both relay outputs.



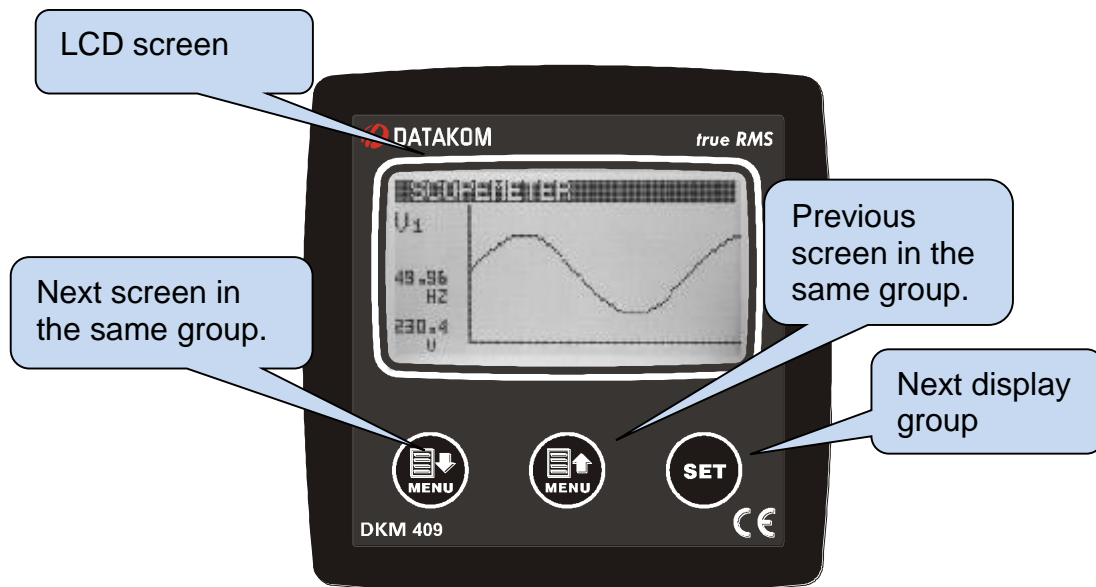

Term	Function	Technical data	Description
	<b>AN1-</b>	Active analog outputs, 0-20mA, non-isolated	These analog outputs transmit information to external PLC systems. Any measured value can be output with adjustable parameters.
	<b>AN1+</b>		
	<b>AN2-</b>		
	<b>AN2+</b>		
	<b>AN3-</b>		
	<b>AN3+</b>		

## 8. DESCRIPTION OF CONTROLS

### 8.1. FRONT PANEL FUNCTIONALITY



### 8.2. PUSHBUTTON FUNCTIONS

BUTTON	FUNCTION
	Selects next display group.  <u>Held pressed for 3 seconds:</u> Remove alarms.
	Selects previous display screen in the same display group. <u>Held pressed for 10 seconds:</u> Current screen will be default display screen
	Selects next display screen in the same display group.
 	<u>Held pressed for 3 seconds:</u> Enable programming mode.

## 8.3. MEASURED PARAMETERS

The unit performs a detailed set of AC measurements.

**The list of measured parameters is below :**

L1-N voltage	L1 active power (kW)
L2-N voltage	L2 active power (kW)
L3-N voltage	L3 active power (kW)
L1-L2 voltage	L1 reactive power (kVAr)
L2-L3 voltage	L2 reactive power (kVAr)
L3-L1 voltage	L3 reactive power (kVAr)
L1 current	L1 apparent power (kVA)
L2 current	L2 apparent power (kVA)
L3 current	L3 apparent power (kVA)
Neutral current	L1 power factor (pf)
Iavg: average current	L2 power factor (pf)
Frequency (Hz)	L3 power factor (pf)
Total Active Power	
Total Reactive Power	
Total Apparent Power	
Total Power Factor	
Average Ph-N Voltage	
Average Ph-Ph Voltage	
Average Current	

### **Harmonic analysis channels:**

L1-N voltage  
 L2-N voltage  
 L3-N voltage  
 L1-L2 voltage  
 L2-L3 voltage  
 L3-L1 voltage  
 L1 current  
 L2 current  
 L3 current  
 Neutral Current

## 9. INDICATOR SYMBOLS



SYMBOL	DEFINITION
Ver	Firmware
U12	Phase 1 - Phase 2 AC RMS Voltage
U23	Phase 2 - Phase 3 AC RMS Voltage
U31	Phase 3 - Phase 1 AC RMS Voltage
FRQ	Frequency
V1	Phase 1 - Neutral AC RMS Voltage
V2	Phase 2 - Neutral AC RMS Voltage
V3	Phase 3 - Neutral AC RMS Voltage
I1	Phase 1 AC RMS Current
I2	Phase 2 AC RMS Current
I3	Phase 3 AC RMS Current
P1	Phase 1 Active Power (kW)
P2	Phase 2 Active Power (kW)
P3	Phase 3 Active Power (kW)
$\Sigma P$	Total Active Power (kW)
Q1	Phase 1 Reactive Power (kVar)
Q2	Phase 2 Reactive Power (kVar)
Q3	Phase 3 Reactive Power (kVar)
$\Sigma Q$	Total Reactive Power (kVar)
S1	Phase 1 Apparent Power (kVA)
S2	Phase 2 Apparent Power (kVA)
S3	Phase 3 Apparent Power (kVA)
$\Sigma S$	Total Apparent Power (kVA)
PF1	Phase 1 Power Factor
PF2	Phase 2 Power Factor
PF3	Phase 3 Power Factor
PF	Total Power Factor
I1mx	Phase 1 Maximum Current
I2mx	Phase 2 Maximum Current
I3mx	Phase 3 Maximum Current
Pmax	Total Maximum Active Power
PI <sub>m1</sub>	Import Power Counter 1 (kWh)
PE <sub>x1</sub>	Export Power Counter 1 (kWh)
PI <sub>m2</sub>	Import Power Counter 2 (kWh)
PE <sub>x2</sub>	Export Power Counter 2 (kWh)
QI <sub>n1</sub>	Inductive Power Counter 1 (kVar)
QC <sub>p1</sub>	Capacitive Power Counter 1 (kVar)
QI <sub>n2</sub>	Inductive Power Counter 2 (kVar)
QC <sub>p2</sub>	Capacitive Power Counter 2 (kVar)
AO-1	Analogue Output 1
AO-2	Analogue Output 2
AO-3	Analogue Output 3
THD	Total Harmonic Distortion
Th...	Total Harmonic of ... (V1,V2,V3,I1,I2,I3,U1,U2,U3)
H03-H49	Harmonics

## 9.1. SCREEN SCROLLING

The unit performs a detailed set of AC measurements. Displaying these parameters are organized under PARAMETER GROUPS and subgroups.

Switching between parameter groups are made with  button.

Each depression of the  button switches the screen to the next parameter group. After the last group, the first group is displayed again.

Switching within the same group is performed with  and  buttons.

Each depression of the  button switches the screen to the next display in the same group. After the last display, the first display comes again.

Each depression of the  button switches the screen to the previous display in the same group. After the first display, the last display comes again.

The list of **parameter groups** are below:

**Measurement Screens:** Voltage, current, kW, kVA, kVAr, pf, active and reactive energy counters.

**Demand Screen:** Demand current, demand power; minimum, maximum of current, voltages, reactive and capacitive powers.

**Status Group:** Various information as date-time, firmware version, identity, configuration, etc...

**User Screens:** Screens in this group are configured by the user.

**Oscilloscope Screens:** In this group, waveforms of currents and voltages may be visualized as an oscilloscope. All phase-neutral and phase-phase voltages and each current input are available. Thanks to this feature, waveform distortions and harmonic components are displayed in graphical form.

**Harmonic Analysis Result Tables:** In this group, THDs of currents and voltages are displayed with 0.1% precision. All phase-neutral and phase-phase voltages and each current input are available.

## 10. WAVEFORM DISPLAY & HARMONIC ANALYSIS

The unit features waveform display together with a precision harmonic analyzer for both voltages and currents. Both phase to neutral and phase to phase voltages are available for analysis.

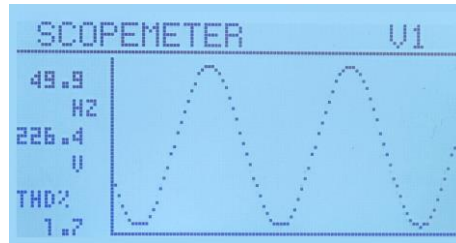

**Scopemeter Display**

The waveform display memory is of 100 samples length and 12 bit resolution, with a sampling rate of 2048 s/s. Thus one cycle of a 50Hz signal is represented with 41 points. The vertical scale is automatically adjusted in order to avoid clipping of the signal.

The waveform is displayed on the device screen, and with more resolution on PC screen through the RainbowPlus program.

The display memory is also available in the Modbus register area for third party applications. For more details please check chapter “**MODBUS Communications**”.

The harmonic analyzer consists on a Fast Fourier Transform (FFT) algorithm which is run twice a second on the selected parameter.

The sample memory is 1024 samples length and 12 bits resolution with a sampling rate of 8196 s/s.

The unit is able to analyze up to 2500Hz and up to 49th harmonic, whichever is smaller.

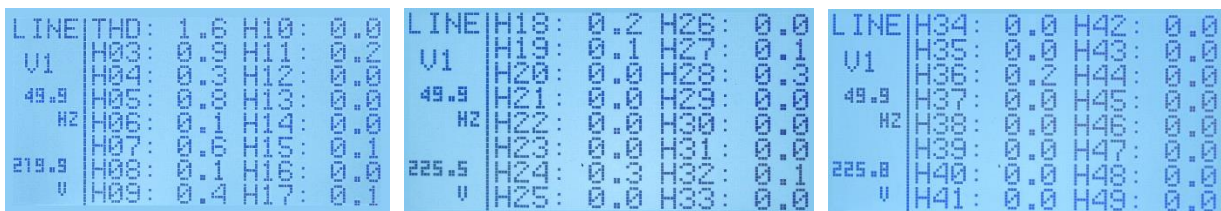

**Harmonics Display Screens**

All harmonics are displayed with 0.1% resolution.

On RainbowPlus program, harmonics and waveform are displayed with more resolution.

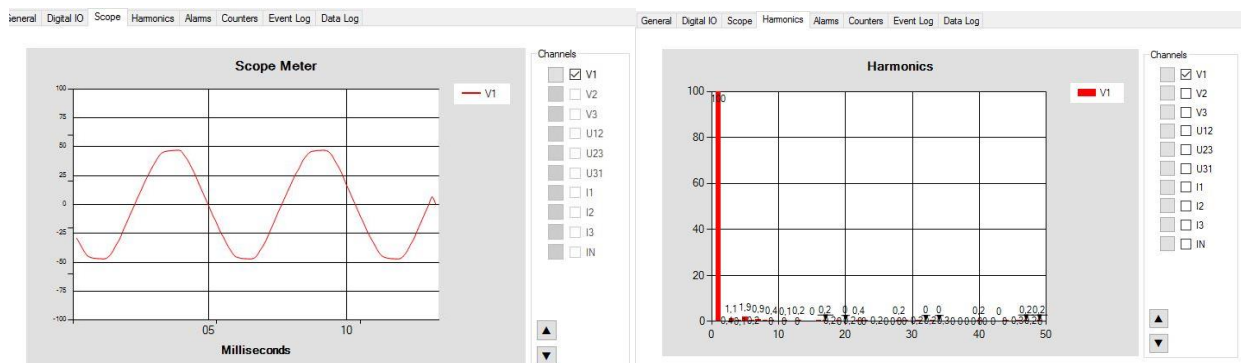

**RainbowPlus Scada section: Waveform Display and Harmonics**

## 11. ASTRONOMIC RELAY FUNCTIONALITY

Thanks to its internal astronomical relay function, the unit calculates sunrise and sunset times with precision, using geographical coordinates and date.

Using the astronomical relay function it is possible turn on/off lights and activate various equipment depending on sunrise and sunset.



*Astronomical relay display screen*

Astronomical relay parameter setting is performed through LOCATION SETUP group of the programming menu.

The date-time information is picked-up from the internal real time clock circuit.

Geographical position information is programmed by direct entry of latitude and longitude.

The unit is capable of activating a relay following sunrise and sunset times. The delay before sunrise and the delay after sunset are programmable.



## 12. USER CONFIGURABLE DISPLAY SCREENS

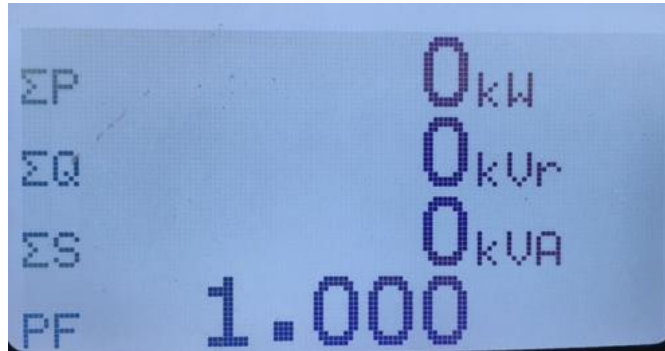

The device offers a powerful user screen design tool through programming menu. The user can freely design his own screen for the most specialized functionality. Any measured value may be set on the display, using 2 different possible font sizes.

The display can hold 4 lines in large characters or 8 lines in small characters. When small characters are used, 2 columns are permitted. The capacity of the screen therefore becomes 4 large size values or 16 small size values or any combination of them. Above is a sample user defined screen.

The device offers 4 independent user defined screens, totalizing the amount of possible parameters to 64 items.

User screen names are also editable for additional flexibility.



**For more details about user screen configuration please review chapter CONFIGURING USER DISPLAY SCREENS at the PROGRAMMING section of this manual.**

## 13. POWER COUNTERS & INCREMENTAL COUNTERS

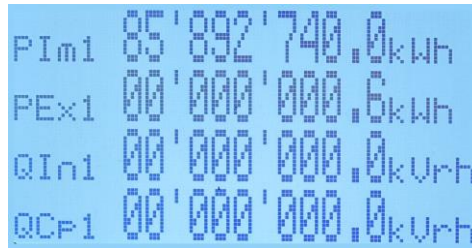

The screenshot shows a digital display with four lines of data. The first line is 'PI m1' followed by '85'892'740.0 kWh'. The second line is 'PE x1' followed by '00'000'000.6 kWh'. The third line is 'QI n1' followed by '00'000'000.0 kVarh'. The fourth line is 'QC p1' followed by '00'000'000.0 kVarh'.

### *Counters*

The unit provides a set of incremental counters for statistical purposes. These counters are stored in a non-volatile memory and retain their values even when power is off.

Incremental counters will count with external signal coming from digital inputs. Therefore external events may be counted and transmitted through internet.

#### **The counters consist on:**

- total imported kWh-1
- total exported kWh-1
- total kVarh inductive-1
- total kVarh capacitive-1
  
- total imported kWh-2
- total exported kWh-2
- total kVarh inductive-2
- total kVarh capacitive-2
  
- hour counter-1
- hour counter-2
- incremental counter-1
- incremental counter-2

## 14. DEMAND VALUES

Demand values are average values of measured parameters over a programmable period.

The average values at the end of the period are compared with the demand registers, if higher, the new demand is stored into the register.

Demand registers are reset at the beginning of each month. Therefore demands are effective for the current month.

Demands may also be manually reset through programming menu MIN/MAX COUNTER ADJUST section.

Demand registers are stored in a non-volatile memory and retain their values even when power is off.

### Below demand registers are available:

- demand I1
- demand I2
- demand I3
- demand Ia (average current)
- demand import active power
- demand export active power

## 15. MIN-MAX VALUES

Min-max values are based on instantaneous measurements. They have no averaging periods, therefore excessive values may be stored during short duration peak demands, like electric motor starts or inrush currents that flow at power-on.

During operation, the unit compares the instantaneous value with the storage registers, if higher, the new value is stored into the register.

Min-max registers are reset through programming mode. The related parameter is:  
**COUNTER/MIN/MAX>Restart Min/Max**

Min-max registers are stored in a non-volatile memory and retain their values even when power is off.

For stability purposes, the min-max detection starts 5 seconds after power turns on.

### Below min-max registers are available

- |                                   |                                   |
|-----------------------------------|-----------------------------------|
| -Min voltage L1-N                 | -Max voltage L1-N                 |
| -Min voltage L2-N                 | -Max voltage L2-N                 |
| -Min voltage L3-N                 | -Max voltage L3-N                 |
| -Min voltage L1-2                 | -Max voltage L1-2                 |
| -Min voltage L2-3                 | -Max voltage L2-3                 |
| -Min voltage L3-1                 | -Max voltage L3-1                 |
| -Min frequency                    | -Max frequency                    |
| -Min current I1                   | -Max current I1                   |
| -Min current I2                   | -Max current I2                   |
| -Min current I3                   | -Max current I3                   |
| -Min current Ia (average current) | -Max current Ia (average current) |
| -Min import active power          | -Max import active power          |
| -Min export active power          | -Max export active power          |
| -Min inductive reactive power     | -Max inductive reactive power     |
| -Min capacitive reactive power    | -Max capacitive reactive power    |

## 16. DISPLAYING EVENT LOGS

The unit features more than 400 event logs with date-time stamp and full snapshot of measured values at the moment that the event has occurred.

### Stored values in an event record are listed below:

- event number
- event type / fault definition (see below for various event sources)
- date and time
- binary values of all alarm, input and output bits.
- Ph-N voltages: V1-V2-V3
- Ph-Ph voltages: U12-U23-U31
- Phase currents: I1-I2-I3
- frequency
- total active power (kW)
- total reactive power (kVAR)
- total apparent power (kVA)
- total power factor
- Total harmonic distortion: V1-V2-V3-U12-U23-U31-I1-I2-I3

Possible event sources are various. Every source can be individually enabled or disabled:

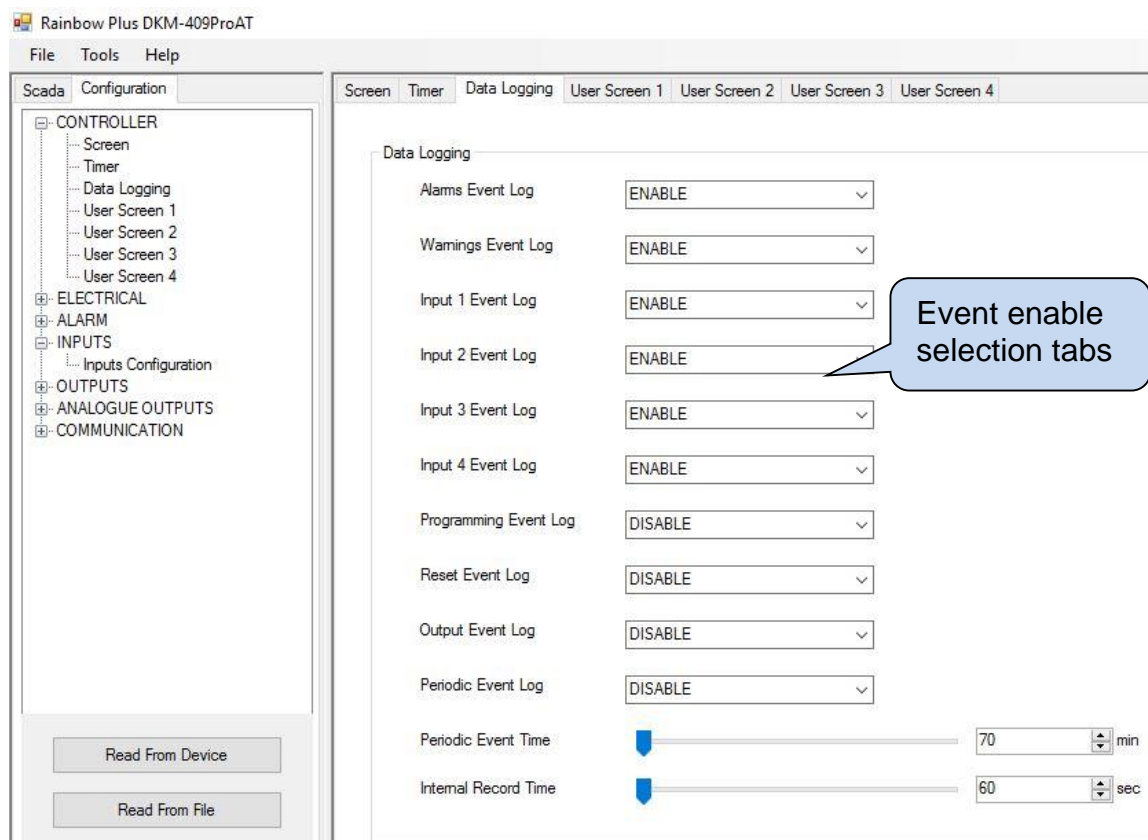

**Alarm events:** recorded when the related fault condition occurs.

**Warning events:** recorded when the related warning condition occurs.

**Input events:** recorded when the status of a digital input is changed.

**Programming event:** Recorded with the password level when program mode is entered.

**Reset event:** recorded when device reset.

**Output event:** recorded when the status of a digital output changes.

**Periodic event:** records measurements and parameters with specified time periods.

Event logs are displayed within the program mode menu. This is designed in order to reduce the interference of event logs with other measurement screens.

To monitor event logs, press together with  and  buttons for 5 seconds.

When the program mode is entered, below password entry screen will be displayed.

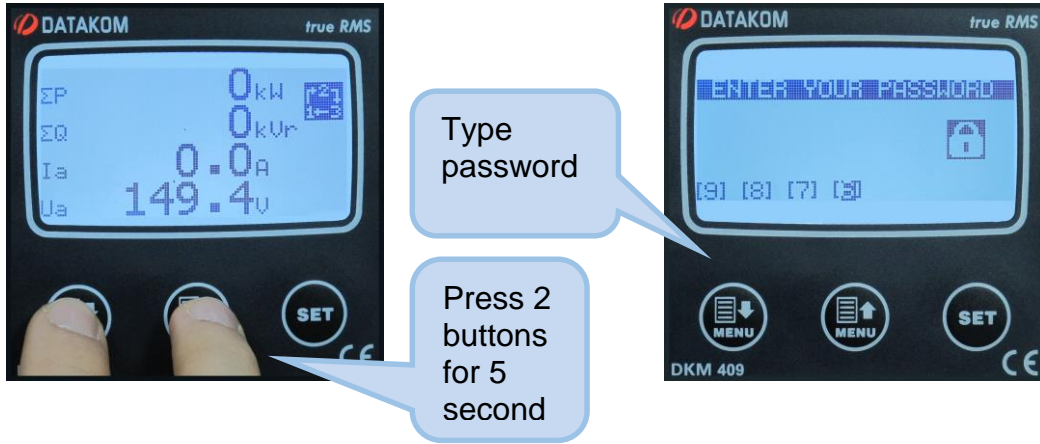

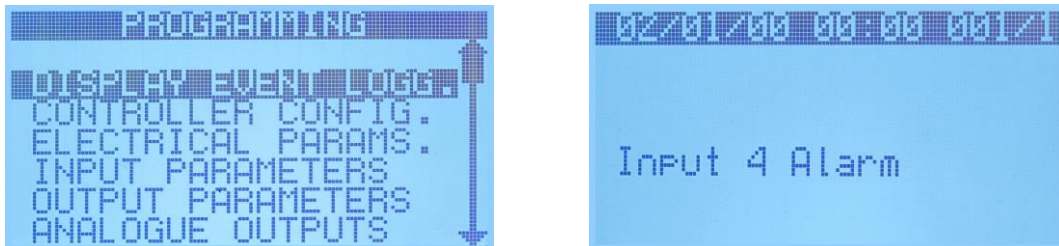

Type password as “9876” by using  and  buttons to increase or decrease the number in highlighted digit,  button to type next digit. Click  button to reach programming mode.

Click  button again to see last stored event. The first page will display the event number, event type, fault type and date-time information.



When displaying event logs:

 button will display the next information in the same event, when held pressed returns to the main programming screen.

 button will display the same information of the previous event

 button will display the same information of the next event.

## 17. PROTECTIONS AND ALARMS

Measured analog values outside of programmed limits cause an ALARM condition.

When an alarm condition occurs, the alarm pop-up display appears and the alarm function will become active. The alarm function may be assigned to a relay output, enabling transfer to other systems.



**If a fault condition occurs, the display will automatically show the alarm pop-up window.**

Each alarm has programmable low/high limits and timer. If the alarm condition disappears before the timer expires, it will not trigger the alarm display.

Alarms may be of **LATCHING** type following programming. For latching alarms, even if the alarm condition is removed, the alarms will stay on.

Most alarms have programmable trip levels. See the programming chapter for adjustable alarm limits.

## 18. PROGRAMMING



The program mode is used to adjust timers, operational limits and the configuration of the unit. Although a free PC program is provided for programming, every parameter may be modified through the front panel.



Program parameters will be automatically recorded into a non-erasable memory and take effect immediately after modification. Moreover, the program mode will not affect the operation of the unit. Therefore, programs may be modified anytime.

### 18.1. ENTERING THE PROGRAMMING MODE

To **enter the program mode**, press and hold  and  buttons for 5 seconds. When the programming mode is activated, password entry screen will be displayed as below;



A 4 digit password must be entered using   and  buttons.

The  ,  buttons modify the value of the current digit. The  button navigate between digits.





The unit supports 3 password levels. The level\_1 is designed for field adjustable parameters. The level\_2 is designed for factory adjustable parameters. The level\_3 is reserved. It allows recalibration of the unit.

The password level-1 is factory set to '1234' and the password level-2 is factory set to '9876'.





### 18.2. NAVIGATING BETWEEN MENUS

The program mode is driven with a two level menu system. The top menu consists on program groups and each group consists on various program parameters.

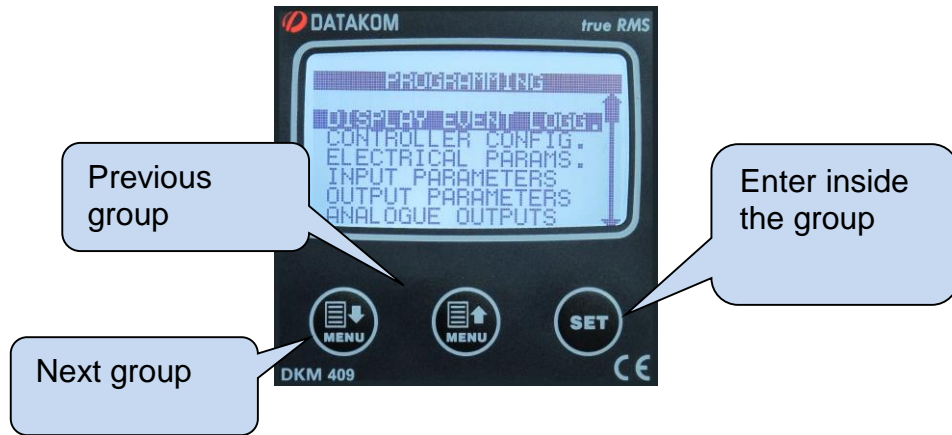
When programming mode is activated, a list of available groups will be displayed. Navigation between different

groups are made with  and  buttons. Selected group is shown in white on black. In order to get inside a group, please press  button. In order to exit from the group to the main list please press and hold  button.



Navigation inside a group is also made with  and  buttons. A list of available parameters will be displayed. Selected parameter is shown in white on black. In order display/change the value of this parameter, please press  button. Parameter value may be increased and decreased with  and  buttons.

When a program parameter is modified, it is automatically saved in memory. If  button is pressed, next parameter will be displayed.

### 18.3. MODIFYING PARAMETER VALUE

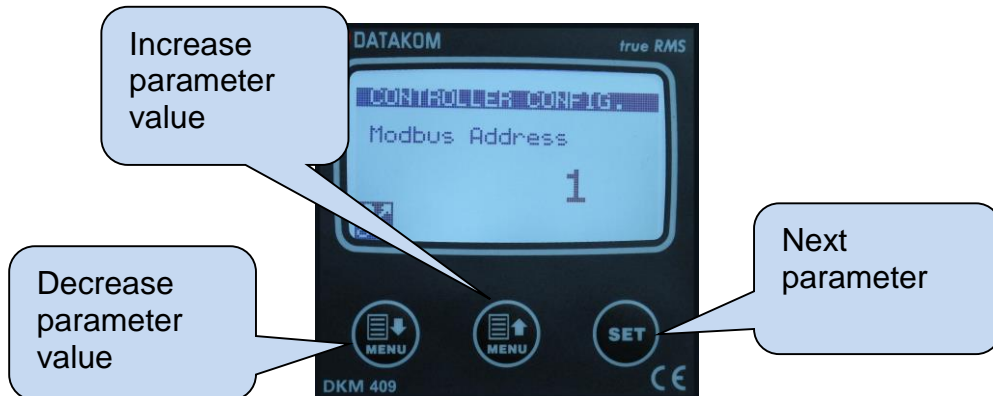

### 18.4. PROGRAMMING MODE EXIT

To **exit the program mode** press one of the mode selection keys. If no button is pressed during 2 minutes the program mode will be cancelled automatically.

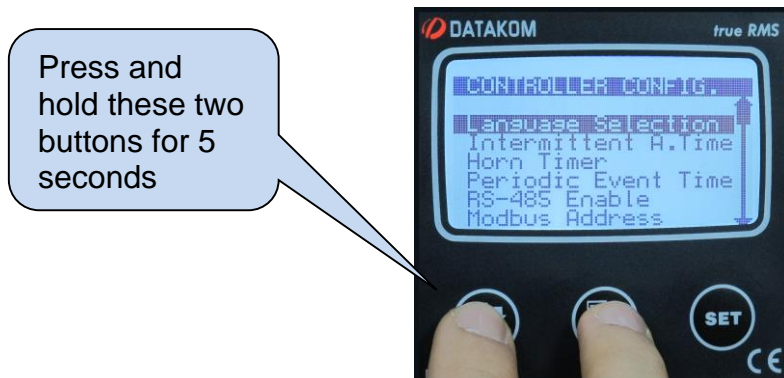



## 19. PROGRAM PARAMETER LIST

### 19.1. CONTROLLER CONFIGURATION GROUP

Parameter Definition	Unit	Min	Max	Factory Set	Description
Language Selection	-	0	1	0	0: English language selected. 1: Local language selected. This language may depend on the country where the unit is intended to be used.
Intermittent Alarm Timer	sec	0	255	1	If Intermittent Relay parameter is 1, then the HORN relay is activated and deactivated with this period.
Horn Timer	sec	0	120	60	This is the period during which the HORN relay is active. If the period is set to 0, this will mean that the period is unlimited.
Periodic Event Time	Min	0	65000	60	Specifies period for periodic data log.
RS-485 Enable	-	0	1	1	0: RS-485 port disabled 1: RS-485 port enabled
Modbus Address	-	0	254	1	This is the modbus controller identity used in Modbus communication.
RS-485 Baud Rate	bps	2400	115200	9600	This is the data rate of the RS-485 Modbus port.
Intermittent Alarm Relay	-	0	1	0	0: Continuous 1: Intermittent
Alarms Event Log	-	0	1	1	0: Disabled 1: Enabled
Warning event Log	-	0	1	1	0: Disabled 1: Enabled
Input 1 Event Log	-	0	1	1	0: Disabled 1: Enabled
Input 2 Event Log	-	0	1	1	0: Disabled 1: Enabled
Input 3 Event Log	-	0	1	1	0: Disabled 1: Enabled
Input 4 Event Log	-	0	1	1	0: Disabled 1: Enabled
Programming Event Log	-	0	1	1	0: Disabled 1: Enabled
Reset Event Log	-	0	1	0	0: Disabled 1: Enabled
Output Event Log	-	0	1	1	0: Disabled 1: Enabled
Periodic Event Log	-	0	1	0	0: Disabled 1: Enabled
LCD Backlight Timer	min	0	1440	0	If no button is pressed during this period, then the unit will reduce the LCD screen backlight intensity in for economy.
Flashing Relay ON Timer	min	0	6000	0	Flashing relay ON state duration timer.
Flashing Relay OFF Timer	min	0	6000	0	Flashing relay OFF state duration.
Internal Record Timer	sec	2	65000	60	Defines the data recording period to internal memory. Shorter periods will cause the internal memory to roll-up more often.
Modbus Packet Type		0	1	0	Do not change this parameter. It affects the Modbus register map.

## 19.2. ELECTRICAL PARAMETERS GROUP

Parameter Definition	Unit	Min	Max	Factory Set	Description
Current Transformer Configuration	-	5/5	25000/1	600/1	This is the primary and secondary windings of current transformer.
Voltage Transformer Ratio	-	0	5000	1.0	This is the voltage transformer ratio. This value will multiply all voltage and power readings. If transformers are not used, the ratio should be set to 1.0
Alarm Mute Timer	sec	0	255	20	If the alarm is selected <b>non-latching</b> , then the alarm condition disappears this timer after the alarm signal goes off.
Mains Phase Order Check Enable	-	0	1	0	0: mains phase order checking disabled 1: if mains phase order is faulty, then an alarm occurs.
Volt Low Alarm	V	0	65000	0	If the voltage of any phase falls below this limit, this will cause an alarm. If this limit is 0 then low voltage alarm is not controlled.
Volt High Alarm	V	0	65000	0	If the voltage of any phase goes above this limit, this will cause an alarm. If this limit is 0 then high voltage alarm is not controlled.
Volt Alarm Duration	sec	0	255	30	If the voltage goes outside of the limits during this timer, a voltage alarm will occur.
Volt Alarm Lock Enable	-	0	1	1	0: alarm non latching 1: latching alarm
Frequency Low Alarm	Hz	0	400	0	If the frequency goes under this limit, this will cause an alarm. If this limit is 0 then the alarm is not controlled.
Frequency High Alarm	Hz	0	400	0	If the frequency goes above this limit, this will cause an alarm. If this limit is 0 then the alarm is not controlled.
Frequency Alarm Duration	sec	0	255	30	If the frequency goes outside of the limits during this timer, a frequency alarm will occur.
Frequency Alarm Lock Enable	-	0	1	1	0: alarm non latching 1: latching alarm
Active Power Low Alarm	kW	0	9999	0	If the active power of any channel goes under this limit, this will cause an alarm. If this limit is 0 then the alarm is not controlled.
Active Power High Alarm	kW	0	9999	0	If the active power of any channel goes above this limit, this will cause an alarm. If this limit is 0 then the alarm is not controlled.
Active Power Alarm Duration	sec	0	255	30	If the active power of any channel goes outside of the limits during this timer, an active power alarm will occur.
Active Power Alarm Lock Enable	-	0	1	1	0: alarm non latching 1: latching alarm

Parameter Definition	Unit	Min	Max	Factory Set	Description
Reactive Power Capacitive Alarm	kVAr	0	9999	0	If the reactive power of any channel is capacitive and goes above this limit, this will cause an alarm. If this limit is 0 then the alarm is not controlled.
Reactive Power Inductive Alarm	kVAr	0	9999	0	If the reactive power of any channel is inductive and goes above this limit, this will cause an alarm. If this limit is 0 then the alarm is not controlled.
Reactive Power Alarm Duration	sec	0	255	30	If the reactive power of any channel goes outside of the limits during this timer, a reactive power alarm will occur.
Reactive Power Alarm Lock Enable	-	0	1	1	0: alarm non latching 1: latching alarm
Power Factor Capacitive Alarm	-	0.000	1.000	0.000	If the power factor of any channel is capacitive and goes below this limit, this will cause an alarm. If this limit is 0 then the alarm is not controlled.
Power Factor Inductive Alarm	-	0.000	1.000	0.000	If the power factor of any channel is inductive and goes below this limit, this will cause an alarm. If this limit is 0 then the alarm is not controlled.
Power Factor Alarm Duration	sec	0	255	30	If the power factor of any channel goes outside of the limits during this timer, a power factor alarm will occur.
Current High Alarm	A	0	25000	0	If the current of any phase goes above this limit, this will cause an alarm. If this limit is 0 then high current alarm is not controlled.
Current Alarm Duration	sec	0	255	30	If the current goes above the limit during this timer, a current alarm will occur.
Current Alarm Lock Enable	-	0	1	1	0: alarm non latching 1: latching alarm
THD-V Alarm	%	0	50	0	If the THD of any voltage channel goes above this limit, this will cause an alarm. If this limit is 0 then the alarm is not controlled.
THD-V Alarm Duration	sec	0	255	30	If the THD of any voltage channel goes above the limit during this timer, a THD-V alarm will occur.
THD-V Alarm Lock Enable	-	0	1	1	0: alarm non latching 1: latching alarm
THD-I Alarm	%	0	50	0	If the THD of any current channel goes above this limit, this will cause an alarm. If this limit is 0 then the alarm is not controlled.
THD-I Alarm Duration	sec	0	255	30	If the THD of any current channel goes outside of the limits during this timer, a THD-I alarm will occur.
THD-I Alarm Lock Enable	-	0	1	1	0: alarm non latching 1: latching alarm

Parameter Definition	Unit	Min	Max	Factory Set	Description
Voltage Unbalance Alarm	%	0	50	0	If the Voltage Unbalance goes above this limit, this will cause an alarm. If this limit is 0 then the alarm is not controlled.
Voltage Unbalance Alarm Duration	sec	0	255	30	If the Voltage Unbalance goes outside of the limits during this timer, a voltage unbalance alarm will occur.
Voltage Unbalance Alarm Lock Enable	-	0	1	1	0: alarm non latching 1: latching alarm
Current Unbalance Alarm	%	0	50	0	If the Currnt Unbalance goes above this limit, this will cause an alarm. If this limit is 0 then the alarm is not controlled.
Current Unbalance Alarm Duration	sec	0	255	30	If the Current Unbalance goes outside of the limits during this timer, a voltage unbalance alarm will occur.
Current Unbalance Alarm Lock Enable	-	0	1	1	0: alarm non latching 1: latching alarm
kW Tick Type	-	0	2	1	0: 1: 2:
Connection Topology	-			0	0: 3 phase, 4 wire, star 1: 1 phase, 2 wire 2: 2 phases, 3 wire 3: 3 phase, 3 wire, delta 4: delta high leg 5: 3 phase, 3 wire, L1-L2 CT 6: 3 phase, 3 wire, L1-L3 CT
Demand Interval	min	1	240	15	This parameter defines the demand interval.
Counter Unit	-	0	1	0	0: counters in kWh 1: counters in MWh

## 19.3. INPUT PARAMETERS

The unit has 4 digital inputs. Only parameters of one input are explained below. Other inputs have identical parameter set.

The input name is freely programmable, thus the input can be adapted to any functionality through programming.



**The input name entry is made through RainbowPlus program only.**

Each digital input has below programmable parameters:

Parameter Definition	Unit	Min	Max	Factory Set	Description
Latching	-	0	1		<b>0:</b> non-latching. The fault disappears when cause is removed. <b>1:</b> latching. The fault persists even if the cause is removed. Requires manual reset.
Response delay	-	0.1	10		This is the delay between the fault signal comes and the alarm occurs.
Contact type	-	0	1		<b>0:</b> Normally open <b>1:</b> Normally closed
Input Function	-	0	99		Selects between predefined input functions. Selected input name is displayed in the line below. <b>0:</b> User function-1 <b>1:</b> User function-2 <b>2:</b> Alarm Mute <b>3:</b> High Temperature <b>4:</b> Panel Lock

### INPUT FUNCTION LIST

No	Description
0	User Function 1
1	User Function 2
2	User Function 3
3	User Function 4
4	User Function 5
5	Reset Input Counter 1
6	Increment Input Counter 1
7	Reset Input Counter 2
8	Increment Input Counter 2
9	Switch Counter
10	Alarm Mute
11	High Temp Switch
12	Panel Lock
15	High frequency alarm

## 19.4. OUTPUT PARAMETERS

The parameters below define the functions of relay outputs. The unit has 2 relay outputs. All relays have programmable functions, selected from a list.



**Below is a short list for reference purposes. Please use the RainbowPlus program for complete selection list.**

### OUTPUT FUNCTION LIST

No	Description	No	Description
1	Horn	31	Currentunbalance Alarm
2	Flashing relay	32	Unbalance alarm
3	Phase order alarm	33	User input alarm-1
4	Voltage alarm	34	User input alarm-2
5	Voltages OK	35	User input alarm-3
6	Internal alarm	36	User input alarm-4
7	Input alarm	37	Button 1 simulation
8	Warning	38	Button 2 simulation
9	Internal alarm or input alarm	39	Button 3 simulation
10	kWh tick	40	Input-1 simulation
11	kVArh tick	41	Input-2 simulation
12	Low voltage alarm	42	Input-3 simulation
13	High voltage alarm	43	Input-4 simulation
14	Low frequency alarm	44	User output 1
15	High frequency alarm	45	User output 2
16	Frequency alarm	46	High neutral current
17	Low kW alarm	47	High ground current
18	High kW alarm	48	Astronomical relay
19	kW alarm		
20	kVAr Capacitive alarm		
21	kVAr inductive alarm		
22	kVAr alarm		
23	Pf capacitive alarm		
24	Pf inductive alarm		
25	Pf alarm		
26	High current alarm		
27	THD-V alarm		
28	THD-I alarm		
29	THD alarm		
30	Voltage Unbalance A.		

## 19.5. ANALOGUE OUTPUTS

The module provides 3 analog outputs. The measurement to output from each channel is selectable from a list. The values for 4mA and 20mA are also programmable.

A program page is reserved for each channel.

Analogue Out 1 Configuration	Parameter settings for the analog output-1
Analogue Out 2 Configuration	Parameter settings for the analog output-2
Analogue Out 3 Configuration	Parameter settings for the analog output-3

Parameter Definition	Unit	Min	Max	Factory Set	Description
Function	-	1	42		<b>0:</b> non-latching. The fault disappears when cause is removed. <b>1:</b> latching. The fault persists even if the cause is removed. Requires manual reset.
Minimum	-				This is the value of the FUNCTION for 4mA output.
Maximum	-				This is the value of the FUNCTION for 20mA output.

The parameters below define the functions of analogue outputs. The unit has 3 analogue outputs. All analogue outputs have programmable functions with maximum and minimum values, selected from a list.

### OUTPUT FUNCTION LIST

No	Description
1	L1-N Voltage
2	L2-N Voltage
3	L3-N Voltage
4	L1-L2 Voltage
5	L2-L3 Voltage
6	L3-L1 Voltage
7	L1 Current
8	L2 Current
9	L3 Current
10	Neutral Current
11	Ground Current
12	L1 Active Power
13	L2 Active Power
14	L3 Active Power
15	Total Active Power
16	L1 Reactive Power
17	L2 Reactive Power
18	L3 Reactive Power
19	Total Reactive Power
20	L1 Apparent Power

No	Description
21	L2 Apparent Power
22	L3 Apparent Power
23	Total Apparent Power
24	L1 Power Factor
25	L2 Power Factor
26	L3 Power Factor
27	Total Power Factor
28	Frequency
29	Supply Voltage
30	Average L-N Voltage
31	L1 power factor
32	L2 power factor
33	L3 power factor
34	Total power factor
35	Frequency
36	Supply voltage
37	Average L-N Current
38	Average L-L Voltage
39	Average L-N Current
40	L1 Q/P Ratio

No	Description
41	L2 Q/P Ratio
42	L3 Q/P Ratio
43	
44	
45	
46	
47	
48	
49	
50	
51	
52	
53	
54	
55	
56	
57	
58	
59	
60	

## 19.6. USER INPUT STRINGS

In this group various texts are entered. These texts appear at top of user screens, as special names for digital inputs or analyzer module names.

## 19.7. MIN/MAX/COUNTER SET



In this group, restarting of demand periods and setting of counter values are performed.

## 19.8. USER SCREENS

4 available user defined screens are configured through this menu.



There are 2 different character sizes that can be selected. (5x7 and 10x14 pixels)

- 1) Please select character size with  and  buttons, then press .

- 2) Please select the value to display through "SELECT AN ITEM" menu, then press .

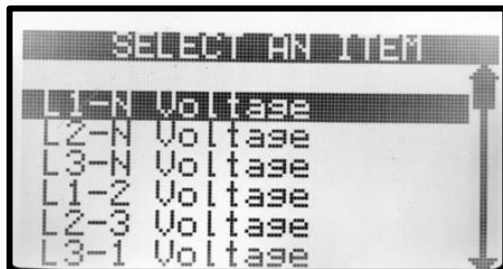

For the next item to display, the menu returns to the character size selection menu. Above steps 1 and 2 may be repeated until the screen is full.

As long as the user stays in the user screen menu, the current appearance of the screen will be on display.



When all available space is occupied, the menu is automatically exited.

If required, the menu may be exited without filling the

screen by holding  button pressed for 3 seconds.



## 19.9. DEVICE SERIAL NUMBER

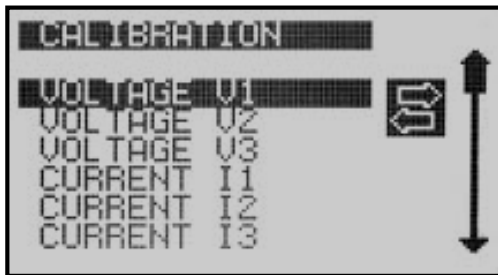

Holds user defined device serial number.

## 19.10. CALIBRATION PARAMETERS



The unit is calibrated during factory production, but it is possible to calibrate again.

Please select “**CALIBRATION PARAMETERS**” menu from PROGRAMMING section.

Then select the input with  and  buttons and press .



Then adjust the coefficient in order to display the correct measured value on the screen and press  button in order to save the new calibration and return to PROGRAMMING section.

## 19.11. ADJUST DATE AND TIME

These parameters allow adjusting the battery backup real time clock of the module. Once set, the clock will continue to run even if supply power is removed from the unit.

Parameter Definition	Unit	Min	Max	Description
Date	-	01	31	Current day of the month.
Month	-	01	12	Current month.
Year	-	00	99	Last two digits of the current year.
Hours	-	00	23	Current hour of the day.
Minutes	-	00	59	Current minute of the hour.
Seconds	-	00	59	Current second of the minute.

## 19.12. CHANGE PASSWORD

The unit has 3 different password levels. Each password consists on a 4 digit number.



**Passwords can only be modified at factory.**

## 19.13. RETURN TO FACTORY SETTINGS

When this menu is selected, the unit will ask for confirmation.

Please adjust required selection with



and



buttons, then press



in order to return to PROGRAMMING section.



**It is not possible to restore previous parameter settings.**

## 19.14. LOCATION SETUP

Parameters adjusted in this section are used in the astronomical relay function.

Parameter Definition	Unit	Min	Max	Factory Set	Description
TIME SOURCE	-	-	-	RTC	The unit picks up the date&time information only from the internal RTC.
LOCATION SOURCE	-	-	-	SET	This parameter determines the source for geographical location information. The unit supports only manual entry.
LATITUDE	degrees	66S	66N	41,000N	This parameter defines the latitude as degrees. <b>NOTE:</b> Sunrise and sunset cannot be calculated for latitudes beyon polar circles.
LONGITUDE	degrees	180W	180E	36,444E	This parameter defines the longitude in degrees.
TIME ZONE	hour	-12	+12	+2	The effective time zone. For eastern longitudes the sign is positive. For western longitudes the sign is negative. Central Europe is generally +1 time zone.
SUNRISE OFFSET	minute			30	Defines the delay before sunrise that the astronomical relay will turn off.
SUNSET OFFSET	minute			30	Defines the delay after sunset that the astronomical relay will turn on.
PLATE CODE	-	1	100	34	Available for Turkey only. Latitudes and longitudes may be automatically selected from list.

## 20. INTERNAL RECORD MEMORY

The 1MB internal memory of the unit holds 15000 records of 64 bytes long.

The record period is adjusted by program parameter: **CONTROLLER CONFIGURATION>Internal Record Timer**.

Records can only be read through Modbus. Please see the MODBUS chapter for the details of record reading.

The Rainbow Plus program offers a way to read and store the internal record memory on computer disk.

Below values are recorded:

- Record date & time
- Statuses of digital inputs & relay outputs
- Analog Output\_1 percentage
- Voltages V1, V2, V3, U12, U23, U31
- Currents I1, I2, I3
- Frequency
- Active powers P1, P2, P3, Ptot
- Reactive powers Q1, Q2, Q3
- Total apparent power
- Average power factor
- Neutral current
- Ground current
- Alarm bits
- THDs V1, V2, V3, U12, U23, U31, I1, I2, I3

## 21. MODBUS COMMUNICATIONS

The unit offers the possibility of MODBUS communication through below carrier:

- RS485 serial port, with adjustable baud rate between 2400 and 115200 bauds

The MODBUS properties of the unit are:

- Data transfer mode: RTU
- Serial data: selectable baud rate, 8 bit data, no parity, 1 bit stop
- Supported functions:
  - Function 3 (Read multiple registers)
  - Function 6 (Write single register)
  - Function 16 (Write multiple registers)

Each register consists of 2 bytes (16 bits). A larger data structure will contain multiple registers.

The Modbus communications requires a slave address to be assigned to each device in the Modbus network. This address ranges between 1 and 240 and allows the addressing of different slave devices in the same network.



**Each device in the same RS-485 serial network must be assigned a different slave address. Otherwise the Modbus communications will not be performed.**

### 21.1. PARAMETERS REQUIRED FOR RS-485 MODBUS OPERATION

**Modbus Slave Address:** may be set between 1 and 240

**RS-485 Enable:** must be set to 1 (or checkbox enabled)

**RS-485 Baud Rate:** selectable between 2400 and 115200 bauds. All devices in the same network must use the same Baud Rate.

Selecting a higher baud rate will allow faster communication, but will reduce the communication distance. Selecting a lower baud rate will increase the communication distance, but will cause slower response times. Typically 9600 bauds will allow 1200m distance with special balanced 120 ohms cable.

### 21.2. DATA FORMATS

**16bit variables:** These variables are stored in a single register. Bit\_0 denotes the LSB and bit 15 denotes the MSB.

**32 bit variables:** These variables are stored in 2 consecutive registers. The high order 16 bits are in the first register and the low order 16 bits are in the second register

**Bit arrays:** Arrays larger than 16 bits are stored in multiple registers. The LSB of the first register is bit\_0. The MSB of the first register is bit\_15. The LSB of the second register is bit\_16. The MSB of the second register is bit\_31, and so on.

### 21.3. DATA READ

Data read can be achieved by using function 03 (read multiple register). MODBUS master device sends query. Respond can be either requested data or failure message including reading fail. 123 Registers can be read by single message. If a single message includes query for more than 123 registers, first 123 registers will be returned. Message structure can be seen below.

BYTE	DESCRIPTION	VALUE
0	Controller Address	1-253
1	Function Code	3
2	Starting Address (Upper)	See below for detailed explanation
3	Starting Address (Lower)	See below for detailed explanation
4	Register Number (Upper)	0
5	Register Number (Lower)	Max 7Bh (123 decimal)
6	CRC Lower Byte	CRC calculation is mentioned below
7	CRC Upper Byte	CRC calculation is mentioned below

Sample message, which reads 16 registers from 20h (32 decimal) address, is explained below.  
01 03 00 20 00 10 45 CC (each byte is written as 2 hexadecimal characters)

Expected return message is:

BYTE	DESCRIPTION	VALUE
0	Controller Address	Same as query
1	Function Code	3
2	Data Length Bytes	Register number x 2
3	1.Register Upper Byte	
4	1.Register Lower Byte	
5	2.Register Upper Byte	
6	2.Register Lower Byte	
...	...	...
L+1	Last Register Upper Byte	
L+2	Last Register Lower Byte	
L+3	CRC Lower Byte	CRC calculation is mentioned below
L+4	CRC Upper Byte	CRC calculation is mentioned below

Failure response message is:

BYTE	DESCRIPTION	VALUE
0	Controller Address	Same as query
1	Function Code	131 (Function code+128)
2	Fail Code	2 (invalid address)
3	CRC Lower Byte	CRC calculation is mentioned below
4	CRC Upper Byte	CRC calculation is mentioned below

## 21.4. DATA WRITE

Writing register values can be accomplished by using function 06 (write single register). Single message can write only one register. MODBUS master device sends query, which includes data to be written. Respond can be either a message that indicates writing process successful, or failure message including writing fail.

BYTE	DESCRIPTION	VALUE
0	Controller Address	1 to 253
1	Function Code	6
2	Register Address Upper	Writeable registers are listed below
3	Register Address Lower	Writeable registers are listed below
4	Data Upper Byte	
5	Data Lower Byte	
6	CRC Lower Byte	CRC calculation is mentioned below
7	CRC Upper Byte	CRC calculation is mentioned below

Sample message, which writes 0010h value to 40h (64 decimal) address, is explained below.  
01 06 00 40 00 10 89 D2 (each byte is written as 2 hexadecimal characters)

Expected response is same as query:

BYTE	DESCRIPTION	VALUE
0	Controller Address	1 to 253
1	Function Code	6
2	Register Address Upper	Writeable registers are listed below
3	Register Address Lower	Writeable registers are listed below
4	Data Upper Byte	
5	Data Lower Byte	
6	CRC Lower Byte	CRC calculation is mentioned below
7	CRC Upper Byte	CRC calculation is mentioned below

Failure response message is:

BYTE	DESCRIPTION	VALUE
0	Controller Address	Same as query
1	Function Code	134 (Function code + 128)
2	Fail Code	2: Invalid Address 10: Write Protection
3	CRC Lower Byte	CRC calculation is mentioned below
4	CRC Upper Byte	CRC calculation is mentioned below

## 21.5. CRC CALCULATION

A method to create CRC is explained as follows,

- 1) Find one 16-bit free register and set all its bits to 1, which will be called as CRC.
- 2) Perform Exclusive OR operation between Lower byte of CRC, and First byte of the message (function code). Write the result at CRC register.
- 3) Identify LSB of CRC, shift CRC register to 1 bit right. Modify MSB as 0.
- 4) Perform Exclusive OR operation between CRC and A001h, if LSB is 1.
- 5) Repeat 3. And 4. steps until 8 bit is shifted.
- 6) Repeat 2. 3. 4. 5. Steps for next 8 bit.
- 7) Remained value of CRC register is called CRC.
- 8) Add CRC to the message so that lower byte is sent first. Algorithm should return correct CRC for messages below.

```
01 03 00 20 00 10 45 CC
01 06 00 40 00 10 89 D2
```

## 21.6. INTERNAL RECORD MEMORY STRUCTURE

The unit has 1 MB internal record memory, consisting of 15000 blocks of 64 bytes.

In order to read the record memory, record number (0...14999) should be written at address "16389". Then the related record can be read from address "4096".

REGISTER ADDRES	VARIABLE	DESCRIPTION	LENGHT	R/W	TYPE	X
+0 +1	Date-Time	32 bit date-time information Bit_0..4: second/2 (0-29) Bit_5..10: minute (0-59) Bit_11..15: hour (0-23) Bit_16..20: day (1-31) Bit_21..24: month (1-12) Bit_25..31: year-2000 (0..127=2000..2127)	32 BIT	R-O	bitmap	
+2_LOW	Type	Log Type	8 BIT	R-O	unsigned byte	-
+2_HIGH	Argument	Log Additional Info	8 BIT	R-O	unsigned byte	-
+3_LOW	Input-Output Status	Bit_0..4: digital input statuses Bit_5..7: digital output statuses	8 BIT	R-O	bitmap	100
+3_HIGH	-	Not Used				
+4	V1	Voltage/Voltage transformer ratio	16 BIT	R-O	Unsigned word	x1
+5	V2					
+6	V3					
+7	U12					
+8	U23					
+9	U31					

REGISTER ADDRES	VARIABLE	DESCRIPTION	LENGHT	R/W	TYPE	X
+10	I1	Current/Current transformer ratio	16 BIT	R-O	Unsigned word	x1000
+11	I2					
+12	I3					
+13	Frequency	Mains Frequency	16 BIT	R-O	Unsigned word	x100
+14	P1	$P1/(\text{Volt Trf. Rat.} \times \text{Current Trf. Rat.})$	16 BIT	R-O	Unsigned word	x1
+15	P2	$P2/(\text{Volt Trf. Rat.} \times \text{Current Trf. Rat.})$	16 BIT	R-O	Unsigned word	x1
+16	P3	$P3/(\text{Volt Trf. Rat.} \times \text{Current Trf. Rat.})$	16 BIT	R-O	Unsigned word	x1
+17	P_tot	$P/(\text{Volt Trf. Rat.} \times \text{Current Trf. Rat.})$	16 BIT	R-O	Unsigned word	x1
+18	Q1	$Q1/(\text{Volt Trf. Rat.} \times \text{Current Trf. Rat.})$	16 BIT	R-O	Unsigned word	x1
+19	Q2	$Q2/(\text{Volt Trf. Rat.} \times \text{Current Trf. Rat.})$	16 BIT	R-O	Unsigned word	x1
+20	Q3	$Q3/(\text{Volt Trf. Rat.} \times \text{Current Trf. Rat.})$	16 BIT	R-O	Unsigned word	x1
+21	V_supply	Supply Voltage	16 BIT	R-O	Unsigned word	x10
+22	S_tot	$S/(\text{Volt Trf. Rat.} \times \text{Current Trf. Rat.})$	16 BIT	R-O	Unsigned word	x1
+23	Cos_tot	Power Factor	16 BIT	R-O	Unsigned word	x1000
+24	I_nötr	Neutral Current/Current TRF. Rat.	16 BIT	R-O	Unsigned word	x1000
+25	Alarm	Alarm Bits	16 BIT	R-O	Unsigned word	-
+26	Alarm	Alarm Bits	16 BIT	R-O	Unsigned word	-
+27_LOW	THD_V1	% THD of V1	8 BIT	R-O	Unsigned word	x1
+27_HIGH	THD_V2	% THD of V2	8 BIT	R-O	Unsigned word	x1
+28_LOW	THD_V3	% THD of V3	8 BIT	R-O	Unsigned word	x1
+28_HIGH	THD_U12	% THD of U12	8 BIT	R-O	Unsigned word	x1
+29_LOW	THD_U23	% THD of U23	8 BIT	R-O	Unsigned word	x1
+29_HIGH	THD_U31	% THD of U31	8 BIT	R-O	Unsigned word	x1
+30_LOW	THD_I1	% THD of I1	8 BIT	R-O	Unsigned word	x1
+30_HIGH	THD_I2	% THD of I2	8 BIT	R-O	Unsigned word	x1
+31_LOW	THD_I3	% THD of I3	8 BIT	R-O	Unsigned word	x1
+31_HIGH	CRC	Checksum: Sum of first 63 byte + 76h	16 BIT	R-O	Unsigned word	-



## 21.7. COMMANDS

REGISTER ADDRES	VARIABLE	DESCRIPTION	LENGHT	R/W	TYPE	X
16384	Password	Programming Password	16 BIT	W-O	Unsigned word	x1
16385	Button	Button Simulation	16 BIT	W-O	Unsigned word	x1
16386	Factory	Return to factory settings	16 BIT	W-O	Unsigned word	x1
16387	Counter Reset	Reset All Counters	16 BIT	W-O	Unsigned word	x1
16388	Read_Flsh	Write on internal flash memory	16 BIT	W-O	Unsigned word	x1
16389	Read_Rec	Copy record to the BUFFER	16 BIT	W-O	Unsigned Word	x1
16390	BOOT	BOOT JUMP	16 BIT	W-O	Unsigned Word	x1
16391	Relay	Remote control relay func. Write	16 BIT	W-O	Unsigned word	x1
16392	kWh1-i	Write at kWh1-import counter	16 BIT	W-O	Unsigned word	x1
16393	kWh1-e	Write at kWh1-export counter	16 BIT	W-O	Unsigned word	x1
16394	kVArh1-i	Write at kVArh1-inductive counter	16 BIT	W-O	Unsigned word	x1
16395	kVArh1-c	Write at kVArh1-capacitive counter	16 BIT	W-O	Unsigned word	x1
16396	Hours_1	Write at Hours_1 counter	16 BIT	W-O	Unsigned word	x1
16397	kWh2-i	Write at kWh2-import counter	16 BIT	W-O	Unsigned word	x1
16398	kWh2-e	Write at kWh2-export counter	16 BIT	W-O	Unsigned word	x1
16399	kVArh2-i	Write at kVArh2-inductive counter	16 BIT	W-O	Unsigned word	x1
16400	kVArh2-c	Write at kVArh2-capacitive counter	16 BIT	W-O	Unsigned word	x1
16401	Hours_2	Write at Hours_2 counter	16 BIT	W-O	Unsigned word	x1
16405	Scope_Ch	Oscilloscope channel (0-9)	16 BIT	W-O	unsigned word	x1

## 21.8. REAL TIME CLOCK

REGISTER ADDRES	VARIABLE	DESCRIPTION	LENGHT	R/W	TYPE	X
8192	Year	Year (0-4096)	16 BIT	R-O	Unsigned word	x1
8193	Month	Month (1-12)	16 BIT	R-O	Unsigned word	x1
8194	Day_Month	Day (1-31)	16 BIT	R-O	Unsigned word	x1
8195	Day_Week	Day of Week (0-6)	16 BIT	R-O	Unsigned word	x1
8196	Hour	Hour (0-23)	16 BIT	R-O	Unsigned word	x1
8197	Minute	Minute (0-59)	16 BIT	R-O	Unsigned word	x1
8198	Second	Second (0-59)	16 BIT	R-O	Unsigned word	x1
8199	Latitude	Latitude (+- 66.499) Negative latitude means "South"	32 BIT	R-O	Signed long	x1000
8201	Longitude	Longitude (+- 179.999) Negative longitude means "West"	32 BIT	R-O	Signed long	x1000

## 21.9. COUNTERS

REGISTER ADDRES	VARIABLE	DESCRIPTION	LENGHT	R/W	TYPE	X
12288	kWh1_I	kWh1_import counter	32 BIT	R-O	Unsigned long	x10
12290	kWh1_E	kWh1_export counter	32 BIT	R-O	Unsigned long	x10
12292	kVArh1_Ind	kVArh1_inductive counter	32 BIT	R-O	Unsigned long	x10
12294	kVArh1_Ca	kVArh1_capacitive counter	32 BIT	R-O	Unsigned long	x10
12296	Hour_2	Hour_1 counter	32 BIT	R-O	Unsigned long	x10
12298	kWh2_I	kWh2_import counter	32 BIT	R-O	Unsigned long	x10
12300	kWh2_E	kWh2_export counter	32 BIT	R-O	Unsigned long	x10
12302	kVArh2Ind	kVArh2_inductive counter	32 BIT	R-O	Unsigned long	x10
12304	kVArh2Cap	kVArh2_capacitive counter	32 BIT	R-O	Unsigned long	x10
12306	Hour_2	Hour_2 counter	32 BIT	R-O	Unsigned long	x10

## 21.10. MEASUREMENTS

REGISTER ADDRESS	VARIABLE	DESCRIPTION	LENGTH	R/W	TYPE	X
20480	V1 RMS	V1 Phase - Neutral Voltage	32 BIT	R-O	Unsigned long	x10
20482	V2 RMS	V2 Phase - Neutral Voltage	32 BIT	R-O	Unsigned long	x10
20484	V3 RMS	V3 Phase - Neutral Voltage	32 BIT	R-O	Unsigned long	x10
20486	U12 RMS	U12 Phase - Phase Voltage	32 BIT	R-O	Unsigned long	x10
20488	U23 RMS	U23 Phase - Phase Voltage	32 BIT	R-O	Unsigned long	x10
20490	U31 RMS	U31 Phase - Phase Voltage	32 BIT	R-O	Unsigned long	x10
20492	I1 RMS	I1 Current	32 BIT	R-O	Unsigned long	x1000
20494	I2 RMS	I2 Current	32 BIT	R-O	Unsigned long	x1000
20496	I3 RMS	I3 Current	32 BIT	R-O	Unsigned long	x1000
20498	IN RMS	Neutral Current	32 BIT	R-O	Unsigned long	x1000
20502	P1	Phase 1 Active Power (kW)	32 BIT	R-O	Signed long	x100
20504	P2	Phase 2 Active Power (kW)	32 BIT	R-O	Signed long	x100
20506	P3	Phase 3 Active Power (kW)	32 BIT	R-O	Signed long	x100
20508	$\Sigma P$	Total Active Power (kW)	32 BIT	R-O	Signed long	x100
20510	Q1	Phase 1 Reactive Power (kVAr)	32 BIT	R-O	Signed long	x100
20512	Q2	Phase 2 Reactive Power (kVAr)	32 BIT	R-O	Signed long	x100
20514	Q3	Phase 3 Reactive Power (kVAr)	32 BIT	R-O	Signed long	x100
20516	$\Sigma Q$	Total Reactive Power (kVAr)	32 BIT	R-O	Signed long	x100
20518	S1	Phase 1 Apparent Power (kVA)	32 BIT	R-O	Signed long	x100
20520	S2	Phase 2 Apparent Power (kVA)	32 BIT	R-O	Signed long	x100
20522	S3	Phase 3 Apparent Power (kVA)	32 BIT	R-O	Signed long	x100
20524	$\Sigma S$	Total Apparent Power (kVA)	32 BIT	R-O	Signed long	x100
20526	Cos $\phi$ 1	Phase 1 Power Factor	16 BIT	R-O	Signed word	x1000
20527	Cos $\phi$ 2	Phase 2 Power Factor	16 BIT	R-O	Signed word	x1000
20528	Cos $\phi$ 3	Phase 3 Power Factor	16 BIT	R-O	Signed word	x1000
20529	$\Sigma$ Cos $\phi$	Total Power Factor	16 BIT	R-O	Signed word	x1000
20530	Frekans	Frequency	16 BIT	R-O	Unsigned word	x100
20532	Va RMS	Average Phase - Neutral Voltage	32 BIT	R-O	Unsigned long	x10
20534	Ua RMS	Average Phase - Phase Voltage	32 BIT	R-O	Unsigned long	x10
20536	Ia RMS	Average Current	32 BIT	R-O	Unsigned long	x1000
20542	Dig-in	Digital Inputs	16 BIT	R-O	16 bit bitmap	-

REGISTER ADDRESS	VARIABLE	DESCRIPTION	LENGTH	R/W	TYPE	X
20543	Dig-out	Digital Outputs	16 BIT	R-O	16 bit bitmap	-
21047	Scope_ch	Oscilloscope Channel Number	16 BIT	R-O	Unsigned word	-
21048-21147	Scope	Oscilloscope Data	16 BIT	R-O	Signed word	x1
21148-21151	Relay F.	Relay Functions	16 BIT	R-O	Array 4x16 bit	-
21152	Anl_1_Val	Analogue Output 1 ADC	16 BIT	R-O	Unsigned word	x1
21153	Anl_2_Val	Analogue Output 2 ADC	16 BIT	R-O	Unsigned word	x1
21154	Anl_3_Val	Analogue Output 3 ADC	16 BIT	R-O	Unsigned word	x1
21155	Anl_1_Rat	Analogue Out 1 %	16 BIT	R-O	Unsigned word	x100
21156	Anl_2_Rat	Analogue Out 2 %	16 BIT	R-O	Unsigned word	x100
21157	Anl_3_Rat	Analogue Out 3 %	16 BIT	R-O	Unsigned word	x100
21158	SF_Page	Last Record Number	16 BIT	R-O	Unsigned word	x1
21159	Event_No	Last Event Record Number	16 BIT	R-O	Unsigned word	x1
21160	Reset_sta	Last Reset Cause	16 BIT	R-O	16 bit bitmap	-
21161	Topology	Topology	16 BIT	R-O	Unsigned word	x1
21162	Dev_Type	Device Model Number	16 BIT	R-O	Unsigned word	x1
21163	SW_Vers	Software Version	16 BIT	R-O	Unsigned word	x1
21164	HW_Cnf	Hardware Configuration	16 BIT	R-O	Unsigned word	x1
21165	Flash_sta	Flash Write Status	16 BIT	R-O	16 bit bitmap	-
21166	Ev_RD_sta	Event Log Read Status	16 BIT	R-O	16 bit bitmap	-
21167	Unlock_cnt	Password Unlock Counter	16 BIT	R-O	Unsigned word	x1
21168-21679	LCD_buf	LCD Buffer	512x16bit	R_O	Array 128x64 bit	-
21680	LCD_sta	LCD Status	16 BIT	R-O	16 bit bitmap	-
21681	Warning	Not-Used	16 BIT	R-O	16 bit bitmap	-
21682	Alarm	Alarm Function Bits 0-15	16 BIT	R-O	16 bit bitmap	-
21683	Alarm	Alarm Function Bits 16-31	16 BIT	R-O	16 bit bitmap	-

## 21.11. ALARM FUNCTION BITS

BIT	DESCRIPTION	BIT	DESCRIPTION
0	High Voltage	16	Input_1 Alarm
1	Low Voltage	17	Input_2 Alarm
2	High Frequency	18	Input_3 Alarm
3	Low Frequency	19	Input_4 Alarm
4	Hihg kW	20	High Neutral Current
5	Low kW	21	
6	High kVAr	22	
7	Low kVAr	23	
8	High Cos	24	
9	Low Cos	25	
10	High Current	26	
11	High THD_V	27	
12	High THD_V	28	
13	Voltage Unbalance	29	
14	Current Unbalance	30	
15	Phase Order Error	31	

## 21.12. HARMONIC MEASUREMENTS

The unit measures up to 50 harmonics and THD values of 10 channels. Harmonics of each channel read from a memory location, which has 50 registers. Memory structure of each channel have same properties.

REGISTER ADDRES	VARIABLE	DESCRIPTION	LENGHT	R/W	TYPE	X
20547	Harm_V1	V1 Harmonics	50x16 bit	R-O	Array 50x16bit	x100
20597	Harm_V2	V1 Harmonics	50x16 bit	R-O	Array 50x16bit	x100
20647	Harm_V3	V1 Harmonics	50x16 bit	R-O	Array 50x16bit	x100
20697	Harm_U12	U12 Harmonics	50x16 bit	R-O	Array 50x16bit	x100
20747	Harm_U23	U23 Harmonics	50x16 bit	R-O	Array 50x16bit	x100
20797	Harm_U31	U31 Harmonics	50x16 bit	R-O	Array 50x16bit	x100
20847	Harm_I1	I1 Harmonics	50x16 bit	R-O	Array 50x16bit	x100
20897	Harm_I2	I2 Harmonics	50x16 bit	R-O	Array 50x16bit	x100
20947	Harm_I3	I3 Harmonics	50x16 bit	R-O	Array 50x16bit	x100
20997	Harm_In	In Harmonics	50x16 bit	R-O	Array 50x16bit	x100

Stored register addresses can be found by adding offsets to base addresses given above.

REGISTER ADDRESS	VARIABLE	DESCRIPTION	LENGTH	R/W	TYPE	X
+0	3. Harmonic	3. Harmonic (%)	16 BIT	R-O	unsigned word	x100
+1	4. Harmonic	4. Harmonic (%)	16 BIT	R-O	unsigned word	x100
....	....	....	...	...	...	...
....	....	....	...	...	...	...
+46	49. Harmonic	49. Harmonic (%)	16 BIT	R-O	unsigned word	x100
+47	50. Harmonic	50. Harmonic (%)	16 BIT	R-O	unsigned word	x100
+48	-	Not-Used	16 BIT	R-O	unsigned word	x100
+49	THD	Total Hamornic Distortion (%)	16 BIT	R-O	unsigned word	X100

### 21.13. DEMAND-MIN-MAX

REGISTER ADDRESS	VARIABLE	DESCRIPTION	LENGTH	R/W	TYPE	X
12308	In_1_Pulse	Input_1 Pulse Counter	32 BIT	R-O	unsigned long	10
12310	In_2_Pulse	Input_2 Pulse Counter	32 BIT	R-O	unsigned long	10
12312	In_3_Pulse	Input_3 Pulse Counter	32 BIT	R-O	unsigned long	10
12314	In_4_Pulse	Input_4 Pulse Counter	32 BIT	R-O	unsigned long	10
12316	In_5_Pulse	Input_5 Pulse Counter	32 BIT	R-O	unsigned long	10
12318	In_1_Time	Input_1 Timer	32 BIT	R-O	unsigned long	10
12320	In_2_Time	Input_2 Timer	32 BIT	R-O	unsigned long	10
12322	In_3_Time	Input_3 Timer	32 BIT	R-O	unsigned long	10
12324	In_4_Time	Input_4 Timer	32 BIT	R-O	unsigned long	10
12326	In_5_Time	Input_5 Timer	32 BIT	R-O	unsigned long	10
12328	Dem_I1	Demand I_1	32 BIT	R-O	unsigned long	10
12330	Dem_I2	Demand I_2	32 BIT	R-O	unsigned long	10
12332	Dem_I3	Demand I_3	32 BIT	R-O	unsigned long	10
12334	Dem_In	Demand I_I_neutral	32 BIT	R-O	unsigned long	10
12336	Dem_kWi	Demand kW_import	32 BIT	R-O	unsigned long	10
12338	Dem_kWe	Demand kW_export	32 BIT	R-O	unsigned long	10
12340	Min_V1	Minimum V1	32 BIT	R-O	unsigned long	10
12342	Min_V2	Minimum V2	32 BIT	R-O	unsigned long	10
12344	Min_V3	Minimum V3	32 BIT	R-O	unsigned long	10
12346	Min_U12	Minimum U12	32 BIT	R-O	unsigned long	10
12348	Min_U23	Minimum U23	32 BIT	R-O	unsigned long	10
12350	Min_U31	Minimum U31	32 BIT	R-O	unsigned long	10
12352	Min_I1	Minimum I1	32 BIT	R-O	unsigned long	10
12354	Min_I2	Minimum I2	32 BIT	R-O	unsigned long	10
12356	Min_I3	Minimum I3	32 BIT	R-O	unsigned long	10
12358	Min_In	Minimum In	32 BIT	R-O	unsigned long	10
12360	Min_Freq	Minimum frequency	32 BIT	R-O	unsigned long	10
12362	Min_kWi	Minimum kW_import	32 BIT	R-O	unsigned long	10
12364	Min_kWe	Minimum kW_export	32 BIT	R-O	unsigned long	10
12366	Min_kVAri	Minimum kVAr_inductive	32 BIT	R-O	unsigned long	10
12368	Min_kVArc	Minimum kVAr_capacitive	32 BIT	R-O	unsigned long	10
12370	Min_V1	Minimum V1	32 BIT	R-O	unsigned long	10

REGISTER ADDRESS	VARIABLE	DESCRIPTION	LENGTH	R/W	TYPE	X
12372	Min_V2	Minimum V2	32 BIT	R-O	unsigned long	10
12374	Min_V3	Minimum V3	32 BIT	R-O	unsigned long	10
12376	Min_U12	Maximum U12	32 BIT	R-O	unsigned long	10
12378	Min_U23	Maximum U23	32 BIT	R-O	unsigned long	10
12380	Min_U31	Maximum U31	32 BIT	R-O	unsigned long	10
12382	Max_I1	Maximum I1	32 BIT	R-O	unsigned long	10
12384	Max_I2	Maximum I2	32 BIT	R-O	unsigned long	10
12386	Max_I3	Maksimum I3	32 BIT	R-O	unsigned long	10
12388	Max_In	Maximum In	32 BIT	R-O	unsigned long	10
12390	Max_Freq	Maximum frequency	32 BIT	R-O	unsigned long	10
12392	Max_kWi	Maximum kW_import	32 BIT	R-O	unsigned long	10
12394	Max_kWe	Maximum kW_export	32 BIT	R-O	unsigned long	10
12396	Max_kVAri	Maximum kVAr_inductive	32 BIT	R-O	unsigned long	10
12398	Max_kVArc	Maximum kVAr_capacitive	32 BIT	R-O	unsigned long	10

## 22. DECLARATION OF CONFORMITY

The unit conforms to the EU directives  
-2006/95/EC (low voltage)  
-2004/108/EC (electro-magnetic compatibility)

Norms of reference:  
EN 61010 (safety requirements)  
EN 61326 (EMC requirements)

The CE mark indicates that this product complies with the European requirements for safety, health environmental and customer protection.

**UL / CSA Conformity:**

UL 61010-1, 3rd Edition, 2012-05,  
CAN/CSA-C22.2  
File: E475547, Vol. D1

## 23. MAINTENANCE



**DO NOT OPEN THE UNIT !**  
**There are NO serviceable parts inside the unit.**

Wipe the unit, if necessary with a soft damp cloth. Do not use chemical agents

## 24. DISPOSAL OF THE UNIT

Following **DIRECTIVE 2002/96/EC OF THE EUROPEAN PARLIAMENT AND OF THE COUNCIL of 27 January 2003 on waste electrical and electronic equipment (WEEE)**, this unit should be stored and disposed separately from the usual waste.

## 25. ROHS COMPLIANCE

The european ROHS directive restricts and prohibits the use of some chemical materials in electronic devices.

Following the “**DIRECTIVE 2011/65/EU OF THE EUROPEAN PARLIAMENT AND OF THE COUNCIL of 8 June 2011 on the restriction of the use of certain hazardous substances in electrical and electronic equipment**”, this product is listed in annex-I under category: “**Monitoring and control instruments including industrial monitoring and control instruments**” and exempted from ROHS directive.

However Datakom is not using any ROHS uncompliant electronic components in the production. Only the solder contains lead. The switching to unleaded soldering is in progress.



## 26. TROUBLESHOOTING GUIDE



Below is a basic list of most often encountered troubles. More detailed investigation may be required in some cases.

### **KW and $\cos\Phi$ readings are faulty although the Amp readings are correct:**

-Current transformers are not connected to the correct inputs or some of the CTs are connected with reverse polarity. Determine the correct connections of each individual CT in order to obtain correct KW and  $\cos\Phi$  for the related phase, and then connect all CTs. Please review chapter “AC CURRENT INPUTS”



**Short circuit outputs of unused Current Transformers.**

### **The unit is inoperative:**

Measure the supply voltage between supply terminals.  
Check that the unit's supply voltage is adequate to operating conditions.  
If OK, turn all fuses off, then turn all the fuses on, starting from the supply fuse. Then test the unit again.

### **Some program parameters are skipped:**

These parameters are reserved for factory setting and cannot be modified.