

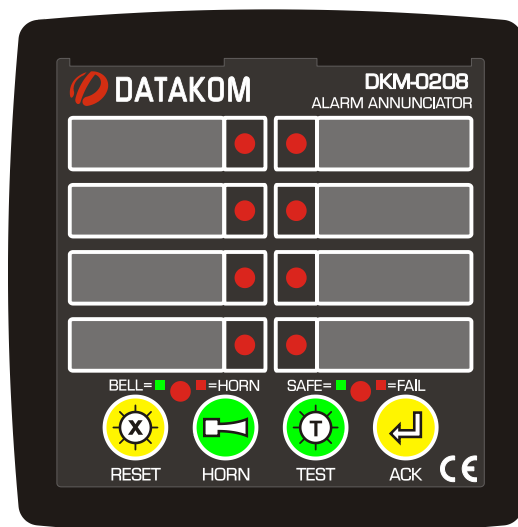

DKM-0208

ALARM ANNUNCIATOR



DESCRIPTION

The DKM-0208 is an 8 channel, 96x96mm alarm annunciator designed to be used in energy and automation systems.

Optically isolated digital inputs are equipped with noise cancelling filters and are capable of operating smoothly in high electrical noise environments. The detection delay of inputs are adjustable between 2 and 500ms.

The module features 3 relay outputs rated at 5Amp. Relays provide Horn, Bell and Internal Failure functions. An additional buzzer is provided inside the unit for audible alarms.

The unit features ultra-bright, bicolor (red-green) led indicators. Alarms may be assigned to different priority levels in order to reduce confusion.

Using front panel pushbuttons, alarms may be acknowledged and reset, the unit tested.

The configuration of the module is performed with jumpers placed on the back panel. Additional programming may be performed from the front panel or through programming software.

The isolated RS-485 MODBUS RTU communication port is free from ground potential differences and allows safe transfer of measured parameters to automation and monitoring systems.

It is possible to monitor the module and keep records with Datakom Rainbow+ software.

The supply input is isolated from other terminals. The module has two supply versions being 19-150V-DC or 85-305V-AC (88-400V-DC).



FEATURES

When the unit detects a fault signal from an input, the related alarm led becomes active.

FAST FLASH: At the first detection of the fault.

SLOW FLASH: Activated when the ACK(alarm acknowledge) pushbutton is pressed and if the fault is still active.

STEADY ON: Activated if the fault signal disappears at SLOW FLASH condition.

LED OFF: The alarm led turns off when RESET pushbutton is pressed and fault signal is not present.

When a fault signal is detected, the internal buzzer turns on with a period of 1 second. If ACK pushbutton is pressed, the buzzer turns off. If ACK is not pressed within 1 minute, then it switches to slow sound mode (beeps once every 10 seconds.)

HORN RELAY: If any "red" alarm led turns on, then the horn relay will also turn on. The relay turns off when ACK pushbutton is pressed.

BELL RELAY: If any "green" alarm led turns on, then the bell relay will turn on. The relay turns off when ACK pushbutton is pressed.

WATCHDOG RELAY: At startup the relay turns on. If the board fails, then it turns off.

HORN/BELL LED: If the HORN relay turns on, the "red" led turns on. If the HORN relay is not on and if the BELL relay is on, then the "green" led turns on. If both relays are off then the led is off.

SAFE/FAIL LED: If an internal fault condition is detected at self-test, then this led will turn on "red", else it turns on "green".

SAFETY NOTICE



CAUTION

**Failure to follow below instructions
will result in death or serious injury**



- Electrical equipment should be installed only by qualified specialist. No responsibility is assured by the manufacturer or any of its subsidiaries for any consequences resulting from the non-compliance to these instructions.



- Check the unit for cracks and damages due to transportation. Do not install damaged equipment.



- Do not open the unit. There are no serviceable parts inside.
- Fuses must be connected to the power supply and phase voltage inputs, in close proximity of the unit.
- Fuses must be of fast type (FF) with a maximum rating of 6A.



- Disconnect all power before working on equipment.



- When the unit is connected to the network do not touch terminals.



- Short circuit terminals of unused current transformers.



- Any electrical parameter applied to the device must be in the range specified in the user manual. Although the unit is designed with a wide safety margin, over-range parameters may reduce lifetime, alter operational precision or even damage the unit.

- Do not try to clean the device with solvent or the like. Only clean with a damp cloth.

- Verify correct terminal connections before applying power.

- Only for panel base mounting.

TABLE OF CONTENTS

1. INSTALLATION INSTRUCTIONS
 - 1.1. FRONT AND BACK PANELS
 - 1.2. MECHANICAL INSTALATION
 - 1.3. ELECTRICAL INSTALLATION
2. PUSHBUTTON FUNCTIONS
3. LED FUNCTIONS
4. SETTINGS
 - 4.1. JUMPER SETTINGS
 - 4.2. SIGNAL LED RED/GREEN SETTINGS
 - 4.3. BUZZER SETTINGS
5. MODBUS COMMUNICATION
 - 5.1. INTRODUCTION
 - 5.2. PROGRAM PARAMETERS
 - 5.3. COMMANDS
 - 5.4. CALCULATED VALUES
6. TECHNICAL SPECIFICATIONS

1. INSTALLATION INSTRUCTIONS

Before Installation:

- Read the user manual carefully, determine the correct connection diagram.
- Remove all connectors and mounting brackets from the unit, then pass the unit through the mounting opening.
- Put mounting brackets and tighten. Do not tighten too much, this can brake the enclosure. Spring type brackets do not need to be tightened.
- Make electrical connections with plugs removed from sockets, then place plugs to their sockets. Otherwise, the sockets may get damaged.
- Be sure that the relay outputs are not over-loaded. Use auxiliary contactors if necessary.

Below conditions may damage the device:

- Incorrect connections.
- Incorrect power supply voltage.
- Voltage at measuring terminals beyond the specified range.
- Current at measuring terminals beyond the specified range.
- Overload or short circuit at relay outputs.

Below conditions may cause abnormal operation:

- Power supply voltage below minimum acceptable level.

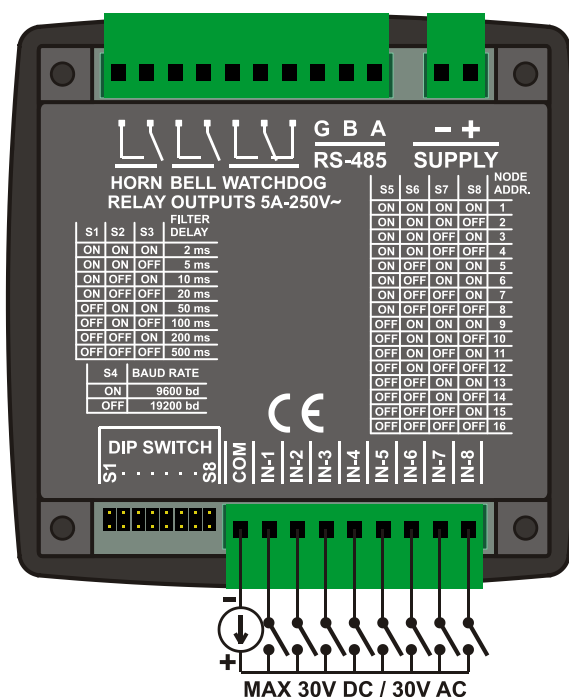

1.1 FRONT and BACK PANELS

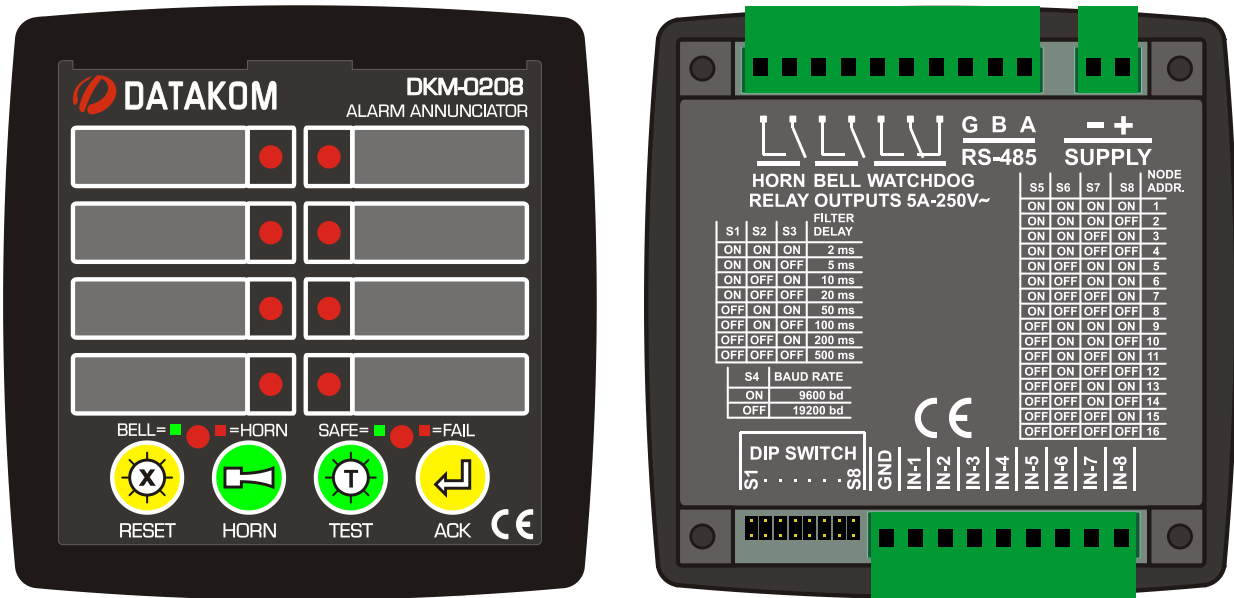

1.2 MECHANICAL INSTALLATION

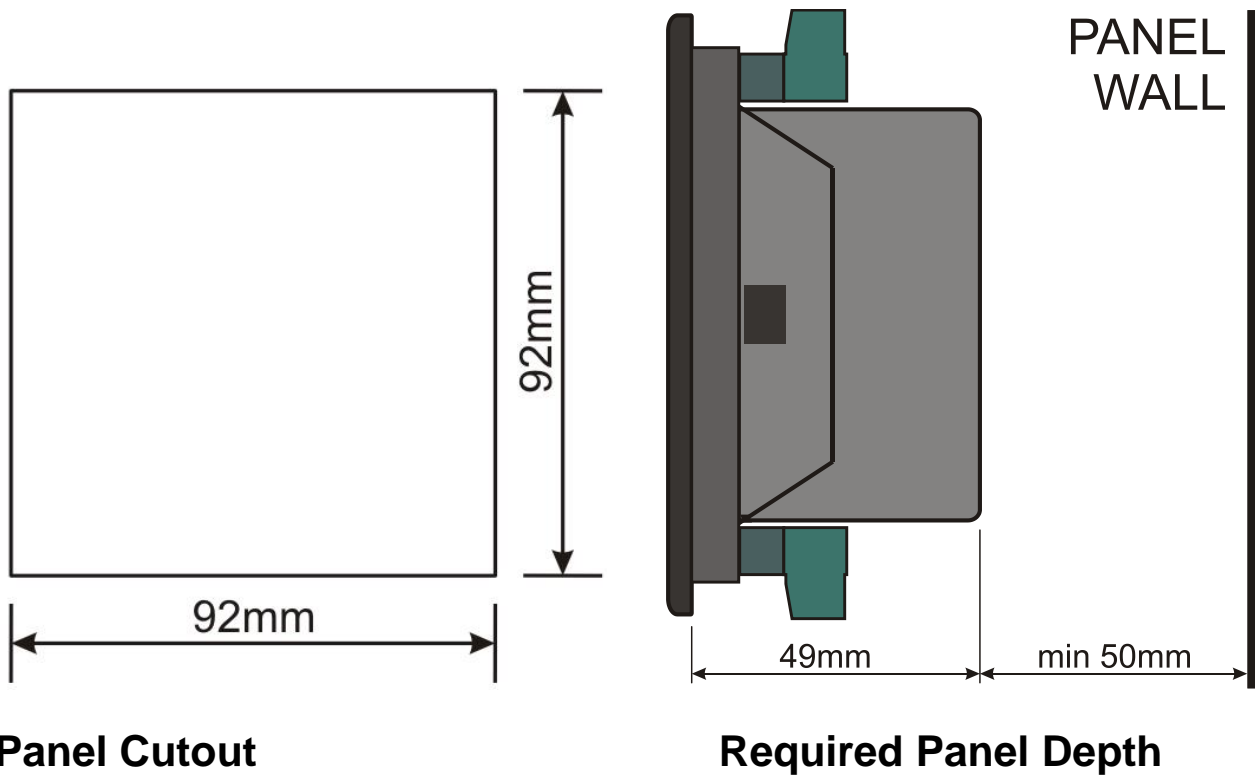

1.3 ELECTRICAL INSTALLATION



Do not install the unit close to high electromagnetic noise emitting devices like contactors, high current busbars, switchmode power supplies and the like.



Although the unit is protected against electromagnetic disturbance, excessive disturbance can affect the operation and measurement precision

- **ALWAYS** remove plug connectors when inserting wires with a screwdriver.
- Fuses must be connected in series with the power supply, in close proximity of the unit.
- Fuses must be of fast type (FF) with a maximum rating of 6A.
- Use cables of appropriate temperature range.
- Use adequate cable section, at least 0.75mm² (AWG18).



**Be sure that the relay outputs are not over-loaded.
Use auxiliary contactors if necessary.**

2. PUSHBUTTON FUNCTIONS

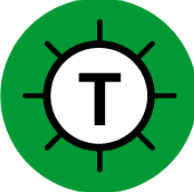
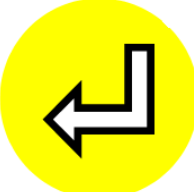
BUTTON	FUNCTION
 <p>RESET</p>	<p>If the pushbutton is pressed all fault leds turn off, Horn and Bell relays are released. If the fault signal still persists, the fault alarm re-appears again. This button is also used in settings menu.</p>
 <p>HORN</p>	<p>If the pushbutton is pressed, all leds flash green and red in sequence, the internal buzzer sounds, Horn, Bell and Watchdog Relays turns on and off with a period of one second. During this test, if the pushbutton pressed for 3 seconds, the buzzer function can be disabled/enabled. By pressing the pushbutton again, the module exits from the test. This button is also used in settings menu.</p>
 <p>TEST</p>	<p>If the pushbutton is pressed, all leds turn-on with the pre-adjusted color. (If it is pressed again, the unit returns back to normal operation.) After pressing it short, if this button is pressed for 3 seconds, then the first Led flashes with the pre-adjusted color and the unit enters the settings menu.</p>
 <p>ACK</p>	<p>If the pushbutton is pressed, fast flashing leds turn into slow flashing(or Steady On) state, the internal buzzer turns off. Horn and Bell relays are released. This button is also used for exiting the settings menu.</p>

3. DISPLAY AND RELAYS

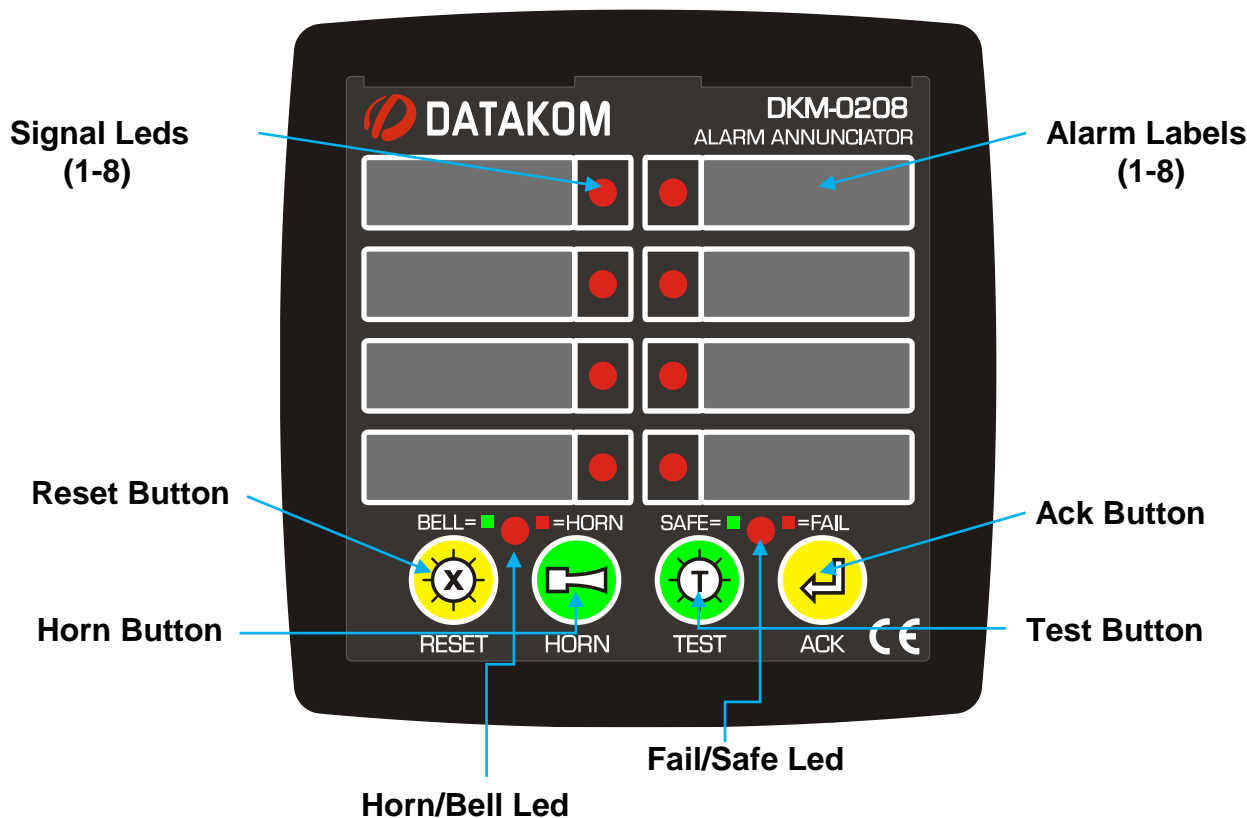

SIGNAL LEDs: There are 8 red/green adjustable signal leds on the panel. According to the input signal and pressed pushbutton, leds can be on Fast Flash, Slow Flash, Steady On and Off states.

FAST FLASH: At the first detection of the fault.

SLOW FLASH: Activated when the ACK(alarm acknowledge) pushbutton is pressed and if the fault is still active.

STEADY ON: Activated if the fault signal disappears at SLOW FLASH condition.

LED OFF: The alarm led turns off when RESET pushbutton is pressed and fault signal is not present.

HORN/BELL LED: If the HORN relay turns on, the “red” led turns on. If the HORN relay is not on and if the BELL

relay is on, then the “green” led turns on. If both relays are off then the led is off.

FAIL/SAFE LED: If an internal fault condition is detected at self-test, then this led will turn on “red”, else it turns on “green”.

HORN RELAY: If any “red” alarm led turns on, then the horn relay will also turn on. The relay turns off when ACK pushbutton is pressed.

BELL RELAY: If any “green” alarm led turns on, then the bell relay will turn on. The relay turns off when ACK pushbutton is pressed.

WATCHDOG RELAY: At startup the relay turns on. If the board fails, then the wathcdog relay turns off.

4. SETTINGS

4.1 JUMPER SETTINGS

The main configuration of the unit is done with jumpers located on back panel. There are 8 jumpers on the unit and the settings are described below.

<u>1-2-3. Jumper:</u>			<u>4. Jumper</u>	<u>5-6-7-8. Jumper:</u>					
Filtering Time Setting:			BaudRate Setting:	Modbus Address Setting:					
<u>1</u>	<u>2</u>	<u>3</u>	<u>4</u>	<u>5</u>	<u>6</u>	<u>7</u>	<u>8</u>		
1	1	1 →	2ms	1 →	9600 baud	8	4	2	1
1	1	0 →	5ms	0 →	19200 baud	There are 16(1-16) addresses can be defined. <u>For example:</u>			
1	0	1 →	10ms			5(OFF),6(OFF),7(OFF),8(OFF)			
1	0	0 →	20ms			1 + 8 + 4 + 2 + 1 = 16			
0	1	1 →	50ms			5(OFF),6(ON),7(ON),8(OFF)			
0	1	0 →	100ms			1 + 8 + 0 + 0 + 1 = 10			
0	0	1 →	200ms			5(ON),6(ON),7(ON),8(ON)			
0	0	0 →	500ms			1 + 0 + 0 + 0 + 0 = 1			

4.2 SIGNAL LED RED/GREEN SETTINGS

Adjusted led colors can be checked by pressing the TEST pushbutton. (If the TEST pushbutton is pressed again, the unit returns back to normal operation) After that, if the TEST pushbutton is pressed long (for 3 seconds) first led flashes with the adjusted color. By pressing RESET pushbutton, signal leds can be selected from up to down, by pressing HORN pushbutton signal leds can be selected from left to right. The color of the signal can be adjusted by pressing the TEST pushbutton. After pressing the ACK pushbutton all leds are seen with the adjusted color. (If the ACK pushbutton is pressed again, the unit returns back to settings menu) After that, if the ACK pushbutton is pressed long (for 3 seconds) the unit saves all settings and exist from the menu.

4.3 BUZZER SETTINGS

If the HORN pushbutton is pressed, all leds flash green and red in sequence, the internal buzzer sounds, Horn, Bell and Watchdog Relays turns on and off with a period of one second. During this test, if the pushbutton pressed long (for 3 seconds) buzzer function can be disabled/enabled. By pressing the pushbutton again, the unit exists from the test.

5. MODBUS COMMUNICATION

5.1 INTRODUCTION

The unit has serial communication port that can be integrated to automation systems.

Serial port is a standart RS-485 MODBUS-RTU isolated from supply input and measuring terminals. Therefore, the unit survives under harsh industrial conditions without any damage.

The MODBUS properties of the unit are:

- Data transfer mode: RTU
- Serial data: 9600 and 19200 bps, 8 bit, no parity, 1 bit stop
- The unit replies within 4.3ms when it receives a message.

Each register consists of 2 bytes(16 bits). Larger data structures will contain multiple registers.

For further details of Modbus Protocol, “**Modicon Modbus Protocol Reference Guide**” can be reviewed. The guide can be downloaded from

www.modbus.org/docs/PI_MBUS_300.pdf

Supported Function:

- Function 3 (Read multiple registers)
- Function 6 (Write single register)
- Function 16 (Write multiple registers)

Error Codes:

There are only 3 error codes are being used:

01: Invalid function code

02: Invalid address

10: Read protection (try to write Read-Only memory)

Data Types:

Each register consists of 16 bits (2 bytes)

If the data type is byte, only low byte is valid. Ignore high byte.

A larger data structure(more than 16bit) will contain multiple registers.

Least significant register comes first.

Baudrate Options:

4th jumper determines Modbus Baudrate.

BaudRate	Value
9600	1
19200	0

5.2 PROGRAM PARAMETERS

There is only one parameter for this unit. Function 10 (Write multiple registers) is used for changing the parameter value.

ADDRESS	NAME	DESCRIPTION	DATA SIZE	R/W	TYPE	X
0	Led 1-8 Settings	Led Color Setting Red: 1, Green:0	16 BIT	R/W	unsigned word	1

5.3 COMMANDS

Function 6 (Write single register) is used for sending commands.

ADDRESS	VALUE	R/W	DESCRIPTION
4	1 and 0	R/W	Buzzer active/deactive(Deactive:1, Active:0)
16384	1	W-O	Reset Button short press
16385	1	W-O	Horn Button short press
16386	1	W-O	Test Button short press
16387	1	W-O	ACK Button short press
16388	1	W-O	Reset Button long press
16389	1	W-O	Horn Button long press
16390	1	W-O	Test Button long press
16391	1	W-O	ACK Button long press

5.4 CALCULATED VALUES

ADDRESS	NAME	DESCRIPTION	LENGTH	R/W	TYPE	X
20480	Filtering Time	Filtering Time of Inputs	16 BIT	R-O	unsigned word	1
20481	Baudrate	Modbus Baudrate Value	16 BIT	R-O	unsigned word	1
20482	Node Adress	Modbus Node Adress Value	16 BIT	R-O	unsigned word	1
20483	Jumper Value	Jumper Value	16 BIT	R-O	unsigned word	1
20484	LED 1-2	1. and 2. Led Instant State	16 BIT(2x8)	R-O	unsigned word	1
20485	LED 3-4	3. and 4. Led Instant State	16 BIT(2x8)	R-O	unsigned word	1
20486	LED 5-6	5. and 6. Led Instant State	16 BIT(2x8)	R-O	unsigned word	1
20487	LED 7-8	7. and 8. Led Instant State	16 BIT(2x8)	R-O	unsigned word	1
20488 - 20495	RESERVED					
20496	Horn/Bell&Fault Led	Horn/Bell&Fault Led State	16 BIT(2x8)	R-O	unsigned word	1
20497	Horn&Bell Relay	Horn&Bell Relay State	16 BIT(2x8)	R-O	unsigned word	1
20498	Fault Relay&Buzzer	Fault Relay ve Buzzer State	16 BIT(2x8)	R-O	unsigned word	1

Led Instant States:

- 0 → Led Off
- 1 → Led Steady On
- 2 → Led Slow Flash
- 3 → Led Fast Flash

Buzzer Instant States:

- 0 → Buzzer Off
- 1 → Buzzer Steady On
- 2 → Buzzer slow frequency(10sec) buzzing
- 3 → Buzzer fast frequency(1sec) buzzing

6. TECHNICAL SPECIFICATIONS

Supply Input: 19-150VDC

(optional 88-400VDC, 85-270VAC)

Power Consumption: < 4 VA

Fault Inputs: 8. Optically isolated, equipped with noise cancelling filters allowing smooth operation in high electrical noise environments, positive inputs and common negative terminal.

Input Impedance: 40K-ohm (opt. 130K-ohm)

Input Current: max. 3mA (110VDC)

Surge Protection: 1000V / 50us

Isolation: 1000VAC, 1 minute

Filter Timing: 2-5-10-20-50-100-200-500msec optional

Optical Warning: 10 red-green bicolor, ultra bright led indicators.

Audible Warning: Internal 23mm buzzer, 80dB

Relay outputs: 3 x 5A @ 250V AC

Serial Port:

Signal Type: RS-485

Protocol: Modbus RTU

Data Rate: 9600-19200baud

Isolation: 1000V AC, 1 minute

Operating Temperature Range: -20°C...+70 °C

Storage Temperature Range: -40°C...+85 °C

Max. Relative Humidity: %95 non-condensing.

Protection: IP 65 (Front Panel, with gasket)
IP 30 (Back panel)

Enclosure: Flame retardant, ROHS compliant, high temperature ABS/PC (UL94-V0)

Installation: Panel mount, rear retaining plastic brackets.

Connections: Two part connection system.

Cable section: max. 2.5mm²

Dimensions: 102x102x53mm (WxHxD)

Panel Cut-ot: 92x92mm

Weight: 200 gr

EU Directives:

2006/95/EC (LVD)

2004/108/EC (EMC)

Norms of Reference

EN 61010 (safety)

EN 61326 (EMC)