

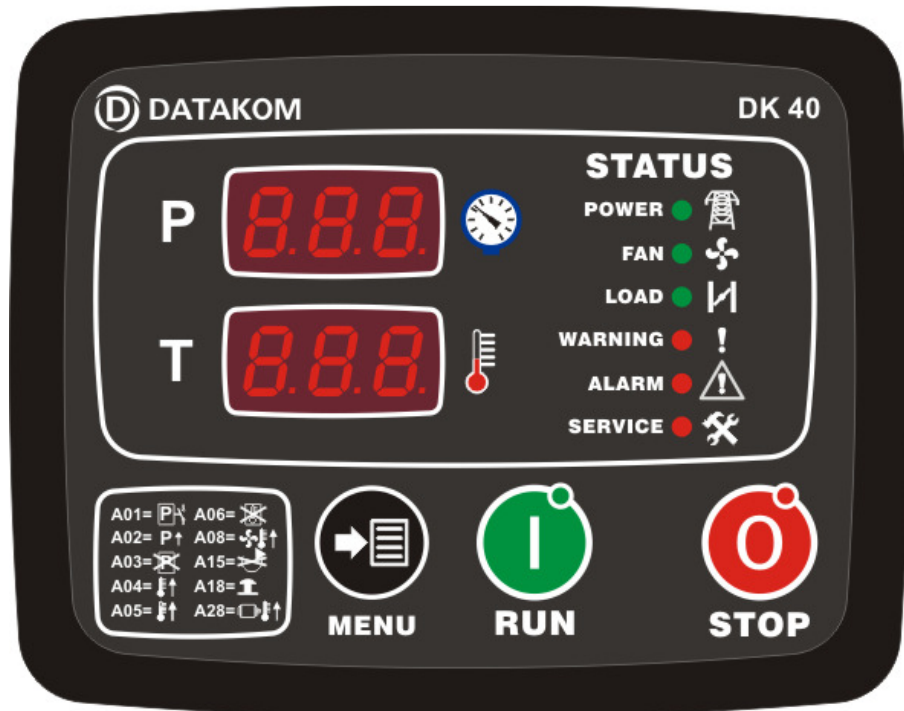

datakom@datakom.com.tr Tel: +90 216 466 84 60  
http://www.datakom.com.tr Fax: +90 216 364 65 65

## DK-40 COMPRESSOR CONTROLLER



### INTRODUCTION

DK-40 is a state of the art unit for the control of both screw and piston type compressors.

The unit integrates all functions needed in a compressor system. Thus no extra units are required in a compressor panel providing cost reduction and simplicity.

The unit is directly powered from 230/400 volt mains. It provides power supply for fault switches and sensors. Thus external transformer is not required in the panel.

The unit monitors mains phase voltages and frequency. It features high/low voltage and phase order protections.

The standard logic level serial port features MODBUS communication. The unit allows monitoring and programming through computer.

### FEATURES

- Pressure driven automatic start and stop***
- Voltage Protection Relay function***
- Phase Order Protection Relay function***
- Mains phase voltages display***
- No need for external transformer***
- Star / Delta startup***
- Load solenoid control***
- 1 programmable relay output***
- Optically isolated configurable digital inputs***
- 2 pressure sensor inputs***
- 2 temperature sensor inputs***
- Additional motor PTC input***
- Logic level serial port***
- MODBUS-RTU communication***
- Password protected front panel programming***
- Low panel depth, easy installation***
- Wide operating temperature range***
- Sealed front panel (IP54)***
- 2 part connector system for easy installation***



## **SAFETY NOTICE**

**Failure to follow below instructions will result in death or serious injury**



- **Electrical equipment should be installed only by qualified specialist. No responsibility is assured by the manufacturer or any of its subsidiaries for any consequences resulting from the non-compliance to these instructions.**
- **Check the unit for cracks and damages due to transportation. Do not install damaged equipment.**
- **Do not open the unit. There is no serviceable parts inside.**
- **Fuses must be connected to the power supply and phase voltage inputs, in close proximity of the unit.**
- **Fuses must be of fast type (FF) with a maximum rating of 6A.**
- **Disconnect all power before working on equipment.**
- **When the unit is connected to the network do not touch terminals.**
- **Any electrical parameter applied to the device must be in the range specified in the user manual.**
- **Do not try to clean the device with solvent or the like. Only clean with a dry cloth.**
- **Verify correct terminal connections before applying power.**
- **Only for front panel mounting.**

**TABLE OF CONTENTS****Section**

- 1. INSTALLATION**
  - 1.1. FRONT / REAR PANELS**
  - 1.2. MECHANICAL INSTALLATION**
  - 1.3. ELECTRICAL INSTALLATION**
  - 1.4. CONNECTION DIAGRAM**
- 2. PUSHBUTTON FUNCTIONS**
- 3. DISPLAY NAVIGATION**
- 4. MODES OF OPERATION**
- 5. ALARMS AND WARNINGS**
- 6. OTHER FEATURES**
  - 6.1. RESETTING SERVICE COUNTERS**
  - 6.2. MODIFYING HOUR COUNTERS**
  - 6.3. SELECTION OF HOUR COUNTING METHOD**
  - 6.4. CONNECTION TOPOLOGIES**
  - 6.5. PREVENTING PRESSURE LOSS**
  - 6.6. ALARM HISTORY**
- 7. INPUTS**
- 8. RELAY OUTPUTS**
- 9. PROGRAMMING**
  - 9.1. INTRODUCTION TO PROGRAMMING**
  - 9.2. PARAMETER LIST**
- 10. MODBUS COMMUNICATIONS**
  - 10.1. DESCRIPTION**
  - 10.2. MODBUS REGISTER LIST**
- 11. MULTIPLE CONTROLLER OPERATION**
- 12. DECLARATION OF CONFORMITY**
- 13. TECHNICAL SPECIFICATIONS**

# 1. INSTALLATION

## **Before installation:**

- Read the user manual carefully, determine the correct connection diagram.
- Remove all connectors and mounting brackets from the unit, then pass the unit through the mounting opening.
- Put mounting brackets and tighten. Do not tighten too much, this can brake the enclosure.
- Make electrical connections with plugs removed from sockets, then place plugs to their sockets.
- Note that the power supply terminal is separated from measurement terminals.

## **Below conditions may damage the device:**

- Incorrect connections.
- Incorrect power supply voltage.
- Voltage at measuring terminals beyond specified range.
- Connecting or removing data terminals when the unit is powered-up.
- Overload or short circuit at relay outputs
- Voltage applied to digital inputs over specified range.
- High voltage applied to communication port.

## **Below conditions may cause abnormal operation:**

- Power supply voltage below minimum acceptable level.
- Power supply frequency out of specified limits

# 1.1 FRONT / REAR PANELS

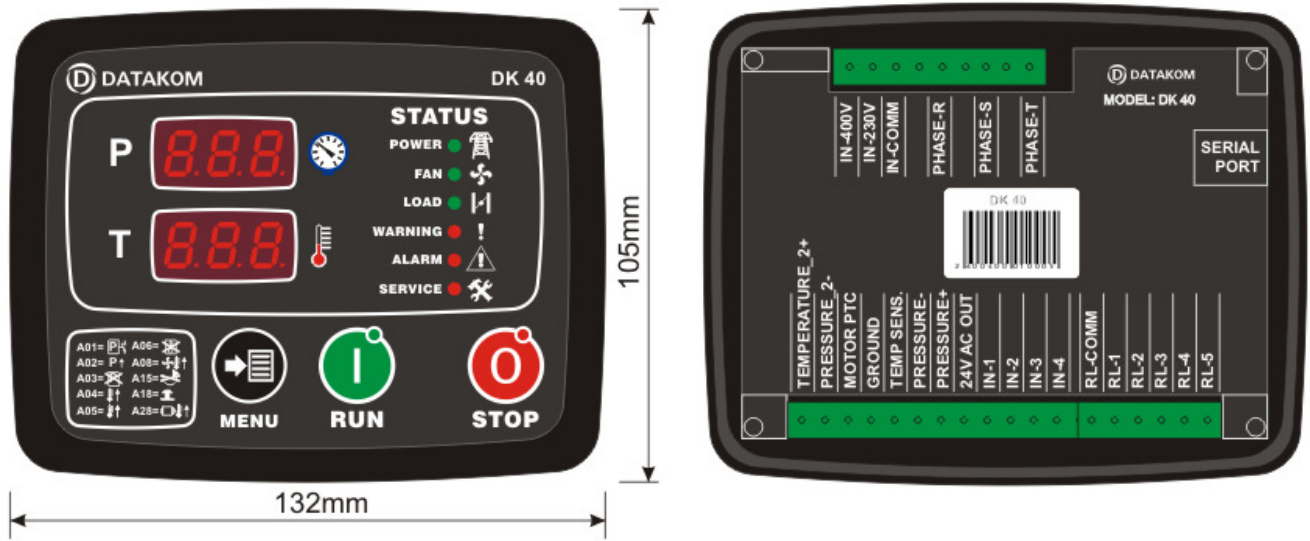

# 1.2 MECHANICAL INSTALLATION

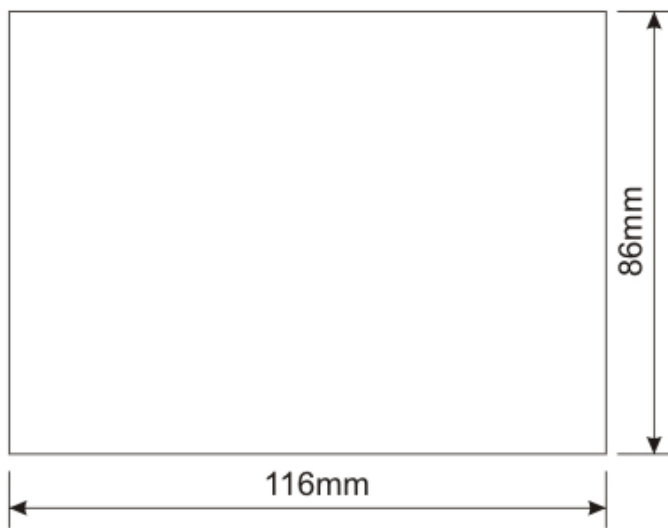

**Panel Cutout**

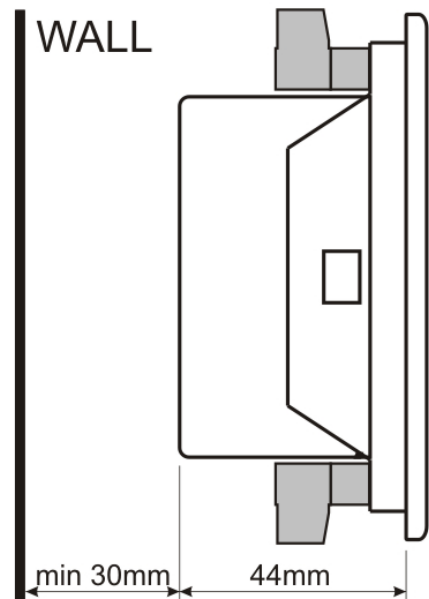

**Required Panel Depth**

## 1.3 ELECTRICAL INSTALLATION



**Do not install the unit close to high electromagnetic noise emitting devices like contactors, high current busbars, switchmode power supplies and the like.**

Although the unit is protected against electromagnetic disturbance, excessive disturbance can affect the operation, measurement precision and data communication quality.

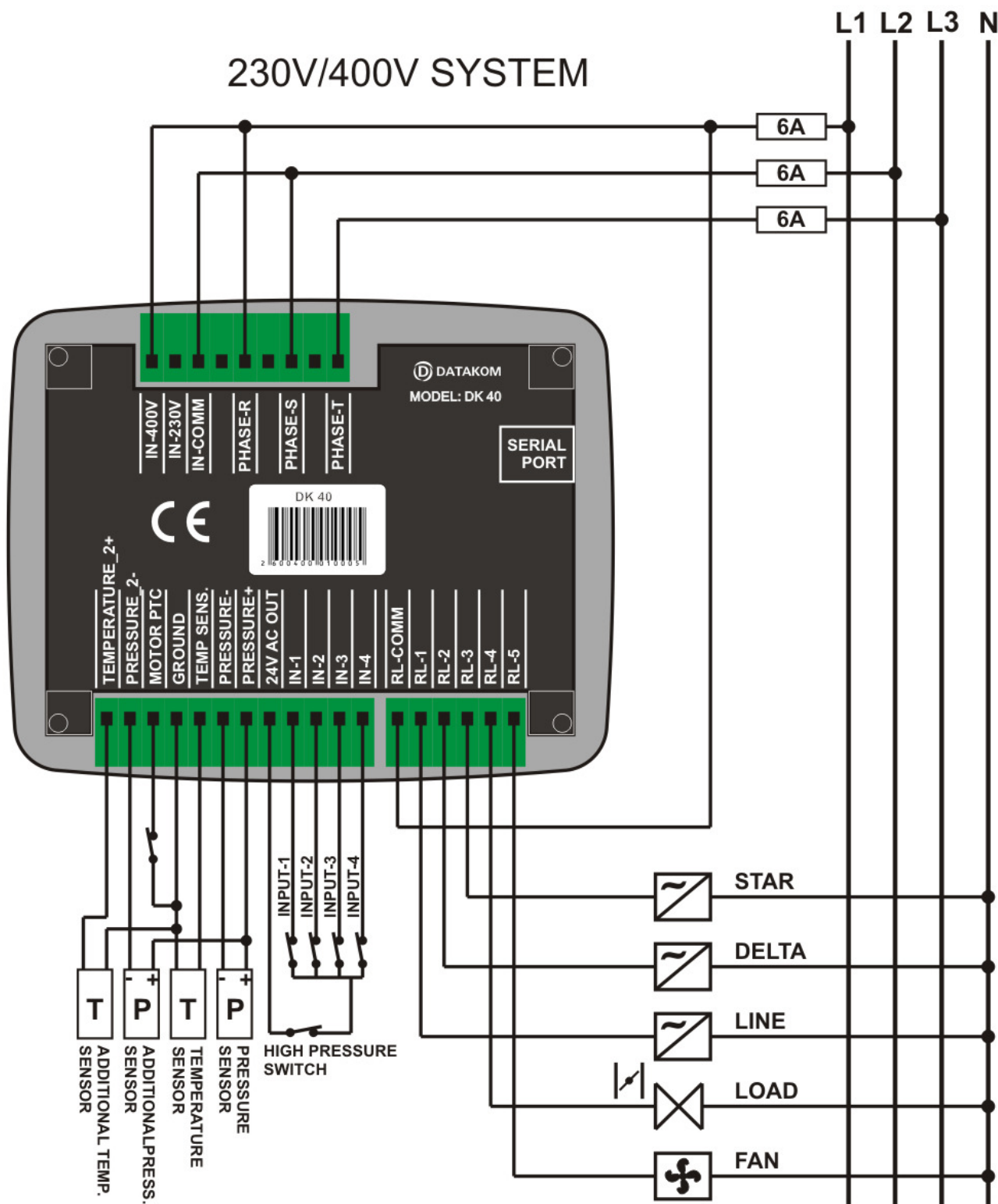

- **ALWAYS** remove plug connectors when inserting wires with a screwdriver.
- **Fuses must be connected to the power supply and phase voltage inputs, in close proximity of the unit.**
- **Fuses must be of fast type (FF) with a maximum rating of 6A.**
- **Use cables of appropriate temperature range.**
- **Use adequate cable section, at least 0.75mm<sup>2</sup> (AWG18).**
- **Follow national rules for electrical installation.**
- **Use only the appropriate cable and connector for serial port connection.**

# 1.4 CONNECTION DIAGRAM



## 2. PUSHBUTTON FUNCTIONS

Programming and measurement displays are visualized using below buttons:



BUTTON	DESCRIPTION	FUNCTION
	<b>MENU</b>	Displays next parameter. Resets faults. Saves adjusted value.
	<b>RUN</b>	Run the compressor and reset existing alarms. Increase value.
	<b>STOP</b>	Stop the compressor and reset existing alarms. Decrease value.



## 3. DISPLAY NAVIGATION

Usually the upper display shows the pressure-1 value or the pressure switch-1 position. The lower display shows the temperature-1.

Other values are scrolled by pressing the MENU  button. For better clarity, the upper display will show the parameter name and the lower display will show the parameter value.

Some parameters are longer than 1 display. For these parameters, when MENU  button is pressed the parameter name appears on the upper display. When MENU  button is released, the parameter value is shown on both displays.



**Display of some parameters are selectable with program parameters and may differ following compressor manufacturers.**



**In the occurrence of a fault condition, the fault code will appear on the upper display.**

Below is a list of messages shown on the upper display in normal operation, programming and alarm display modes:

MESSAGE	DESCRIPTION	MODE
bAr SEt	Start pressure and stop pressure set values	Display
F <sub>r</sub> 9	Mains frequency	Display
L 12	L1-L2 phase-to-phase voltage	Display
L 23	L2-L3 phase-to-phase voltage	Display
L 3 1	L3-L1 phase-to-phase voltage	Display
SHa	Hours remaining to service A	Display / Program / Alarm
SHb	Hours remaining to service B	Display / Program / Alarm
SHc	Hours remaining to service C	Display / Program / Alarm
SHd	Hours remaining to service D	Display / Program / Alarm

MESSAGE	DESCRIPTION	MODE
SHE	Hours remaining to service E	Display / Program / Alarm
C-H	Total compressor hours (ON_LOAD+OFF_LOAD+STOP)	Display
r-H	Total Run Hours (ON_LOAD+OFF_LOAD)	Display
L-H	Total load time (load contactor active)	Display
o/o	Load hours / Run hours percentage	Display
E-t	Motor PTC value or switch position	Display
t-2	Temperature-2 value or switch position	Display
d-P	Differential Pressure	Display
n--	Remaining starts for the last hour	Display
r-EL	Software version	Display
Ah 1	Alarm history 1	Display
n-C	Switch closed	Display
n-O	Switch open	Display
SEP	Waiting for separator filter pressure drop	Display
StP	Remote Stop mode	Display
rUn	Remote Start mode	Display
AL 1	Alarm code 01	Display
A99	Alarm code 99	Display
P99	Program parameter 99	Program
USr	Enter password	Program
SEL	Select parameter	Program

## 4. MODES OF OPERATION

### Selecting the operating mode:

At power-up, the unit will turn all lights on for 3 seconds in order to allow lamp check. Then it goes in the STOP mode and the stop led turns on.

The compressor may be run through Remote Start signal (upper display shows *rUn* for 5 seconds) or by pressing the RUN  button.

If **P28 Safety Timer** has not elapsed, the run led will flash until expiration of the timer. Then if the pressure is below the limit set by **P05 Start Pressure**, then the compressor will run.





**In the occurrence of an alarm the compressor stops immediately and the upper display shows the alarm code. A comprehensive list of alarm codes is given in chapter 5.**

The compressor may be stopped with Remote Stop signal (upper display shows *StP* for 5 seconds) or the STOP  button.

### Stop procedure:

STOP led starts flashing.

If the compressor is loaded, then the LOAD relay will release and the compressor continues to run during **P28 Safety Timer** or **P26 Unload Timer** (whichever is longer).

At this step, operation may be resumed by pressing the RUN  button. If STOP  button is pressed during unloaded operation, then the compressor stops immediately.

The stop led flashes until the compressor comes to complete stop.



**When STOP  button is pressed, if the compressor is running unloaded, then it will continue to run until expiration of P26 Unload Timer. The compressor may be immediately stopped by pressing again the STOP  button.**

## **Start procedure:**

If mains phase voltages and frequency are between preset limits and the phase order is correct, then the POWER led will turn on. The compressor may run only when the power led is on. Otherwise it cannot run.

The Run mode of operation is selected by pressing the RUN  button or by sending REMOTE START/STOP signal (if enabled). At this position, when the pressure falls below **P05 Start Pressure** (or pressure switch closes) the unit decides to run the compressor.

Before running the compressor the STAR relay output becomes active. After **P15 Delay between Relays Timer** LINE relay will be activated. Thus the motor starts in star mode.

After **P23 Star Timer** the STAR relay opens and after **P24 Star/Delta Transition Timer** the DELTA relay operates.

After **P25 Timer before Loading** the LOAD relay operates and the compressor starts producing compressed air.

## **Unloading and reloading:**

When the pressure reaches **P04 Stop Pressure** (or pressure switch opens) then the LOAD relay opens and the compressor runs unloaded during **P26 Unload Timer**. If the pressure falls below P05 Start Pressure before the expiration of the timer, then the LOAD relay energizes again.

## **Stopping and restarting:**

If the pressure stays over the **P05 Start Pressure limit** (or pressure switch opened) during **P26 Unload Timer**, then the DELTA relay will release. After **P15 Delay between Relays** timer, the LINE relay releases.

In this situation, the RUN led starts flashing.

The maximum number of starts that the compressor may perform in one hour is adjusted with **P37 Maximum Starts per Hour** parameter.

If the maximum start count is reached, then the compressor stopping is disabled and it will continue to run unloaded until the end of 1 hour period.

## 5. ALARMS AND WARNINGS

Abnormal situations in the compressor are evaluated under 3 different categories as ALARMS, WARNINGS and SERVICE REQUESTS.

Warnings are lowest level fault conditions and generate only visual warning, not affecting the compressor operation.





Alarms are highest level fault conditions and cause the compressor to stop immediately, the alarm relay to become active (if enabled by programming) and visual warning to occur.

If any fault condition occurs, the fault code will appear on the upper display and the related fault category led turns on. (WARNING, ALARM or SERVICE)

Alarms and warnings may be reset by pressing the MENU  button. The EMERGENCY STOP alarm cannot be reset by pressing buttons, the alarm signal must be removed.



**Service warnings may affect the compressor operation depending on the amount exceeding the service period.**

TIME REMAINING TO SERVICE	REACTION
> 100 hours	No warning given.
100hours	Service warning is given and SERVICE led turns on. The compressor continues normal operation.
0 hour	The compressor stops. Service warning is given and SERVICE led turns on. The compressor resumes normal operation when RUN  button is pressed.
-100 hours	The compressor stops. Service warning is given and SERVICE led turns on. The compressor resumes normal operation when RUN  button is pressed.
-120 to -200 hours, every 20 hours	The compressor stops. Service warning is given and SERVICE led turns on. The compressor resumes normal operation when RUN  button is pressed.
-210 to -300 hours, every 10 hours	The compressor stops. Service warning is given and SERVICE led turns on. The compressor resumes normal operation when RUN  button is pressed.
-300 hours	The compressor stops. Service warning is given and SERVICE led turns on. The compressor will not operate again unless the service counter is reset.

## **FAULT CODES LIST**

<b>SYMBOL</b>	<b>CODE</b>	<b>DESCRIPTION</b>	<b>TIP</b>
AL1	01	Security Pressure Switch Opened	ALARM
AL2	02	High Pressure	ALARM
AL3	03	Pressure Sensor Fail	ALARM
AL4	04	High Temperature	ALARM
AL5	05	High Temperature	WARNING
AL6	06	Temperature Sensor Fail	ALARM
AL7	07	Low Temperature	ALARM
AL8	08	Fan Motor High Temperature	ALARM
AL9	09	Motor PTC High Temperature	ALARM
A10	10	Voltage Unbalance	ALARM
A11	11	High Voltage	ALARM
A12	12	Low Voltage	ALARM
A13	13	High Frequency	ALARM
A14	14	Low Frequency	ALARM
A15	15	Phase Squence Fail	ALARM
A16	16	Air Filter Clogged	WARNING
A17	17	Maximum starts per hour exceeded	WARNING
A18	18	Emergency Stop	ALARM
A19	19	Internal Warning	WARNING
A20	20	Pressure Difference	ALARM
A21	21	High Pressure-2	ALARM
A22	22	Pressure-2 Sensor Fail	ALARM
A23	23	High Temperature-2 / Delta (tS2-tS1)	ALARM
A24	24	Temperature-2 Sensor Fail	ALARM
A25	25	Low Temperature-2	ALARM
A26	26	Air In Separator	WARNING
A27	27	Delta Temperature-2 Warning	WARNING
A28	28	Main Motor thermal	ALARM
A29	29	Low Pressure-2	ALARM
SHA	100	Service A Period Elapsed	SERVICE
SHb	101	Service B Period Elapsed	SERVICE
SHC	102	Service C Period Elapsed	SERVICE
SHD	103	Service D Period Elapsed	SERVICE
SHE	104	Service E Period Elapsed	SERVICE
Stp	200	Remote Stop	-







## 6. OTHER FEATURES

### 6.1. RESETTING SERVICE COUNTERS



**Service counters can only be reset when the compressor is in STOP mode.**

#### In order to reset service counters:

- Hold MENU  and RUN  buttons pressed for 3 seconds. If the high level password is not entered in the last 90 minutes, the unit will ask the password.
- Enter the password.
- The upper display will show **SHA** hours remaining for SERVICE A message.
- Press again the MENU  button. The hours remaining for SERVICE A will appear flashing on the display.
- In order to reset the hours remaining for SERVICE A, hold pressed MENU  button for 3 seconds.
- The upper display will show the next service counter which is **SHb** hours remaining for SERVICE B message.
- Press again the MENU  button. The hours remaining for SERVICE B will appear flashing on the display.
- In order to reset the hours remaining for SERVICE B, hold pressed MENU  button for 3 seconds.
- By pressing the MENU  button again, below counters can be scrolled and reset:

**SHc** : hours remaining for SERVICE C

**SHd** : hours remaining for SERVICE D

**SHe** : hours remaining for SERVICE E



**After the last counter, the display will return to pressure-temperature display mode.**

## 6.2. MODIFYING HOUR COUNTERS







The unit holds 3 different run hour counters:

MESSAGE	DESCRIPTION
<b>C-H</b>	Total compressor hours (ON_LOAD+OFF_LOAD+STOP) This counter increments while the RUN led is on.
<b>r-H</b>	Total motor run hours (ON_LOAD+OFF_LOAD) This counter increments while the motor runs.
<b>L-H</b>	Total load time (load contactor active) This counter increments while LOAD led is on.



**Hour counters can only be modified while the compressor is in STOP mode.**

### In order to modify hour counters:

- Hold pressed together MENU , RUN  and STOP  buttons for 3 seconds. If the high level password is not entered in the last 90 minutes, the unit will ask password (U5r).
- Enter password.
- The upper display will show **C-H** message.
- Adjust required hour counter value with RUN  and STOP  buttons.
- Press MENU  button for 3 seconds, the display will show SEt message and the counter will be adjusted to the new value. If MENU  button is pressed for short duration, then the value will not be modified and the next hour counter will be displayed. Same steps are repeated for further modification.



**After modifications, the display will return to pressure-temperature display mode.**



## 6.3. SELECTION OF HOUR COUNTING METHOD

The unit offers the possibility of incrementing hour counters with a variable coefficient, depending on air end temperature.

The use of variable coefficient is selected with P89 Variable Hour counting coefficient. If this parameter is 0, all service and hour counters will increment with a fixed coefficient of 1.00.

If Variable Hour Counting is activated:

### **Running on load:**

below 90 °C, coefficient = 1.00

between 90 and 95 °C, coefficient = 1.50

between 95 and 100 °C, coefficient = 2.00

above 100 °C, coefficient = 3.00

### **Running off load**

below 90 °C, coefficient = 0.50

between 90 and 95 °C, coefficient = 0.75

between 95 and 100 °C, coefficient = 1.00

above 100 °C, coefficient = 1.50





**These coefficients apply to both service and compressor hour counters.**

## 6.4. CONNECTION TOPOLOGIES

The unit supports various connection topologies. The topology is selected through parameter **P48**.

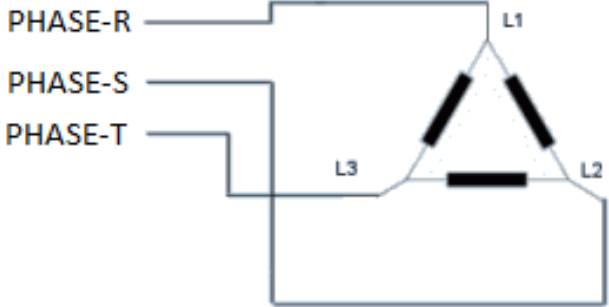
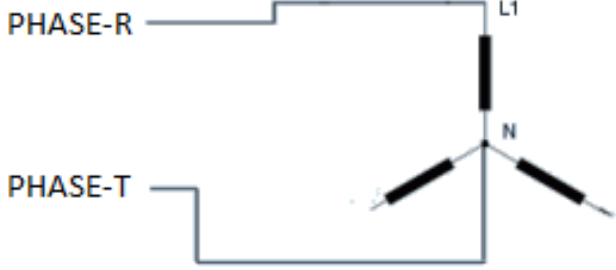
Different topologies and terminal connections are as below:

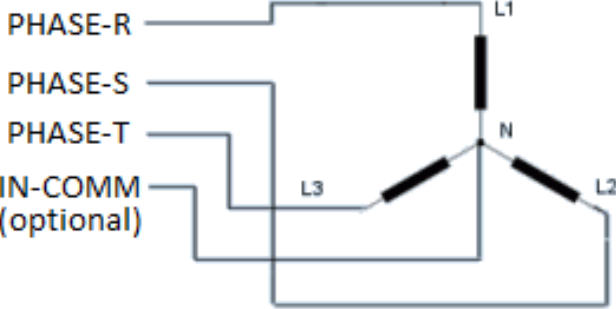
 <p><b>P48 = 3</b></p>	 <p><b>P48 = 1</b></p>
 <p><b>P48 = 2</b></p>	 <p><b>P48 = 3</b></p> <p>The power supply and measuring terminals of the unit are isolated. In order to enable above topology, the unit must be specially manufactured.</p>

## 6.5. PREVENTING PRESSURE LOSS

If the pressure stays above the **P05 Start Pressure**, during **P26 Unload Timer** then the unit will stop the motor. If the pressure falls below **P05 Start Pressure** then the motor will run again.

Before the compressor is loaded, a timer equal to **P23+P24+P25+P15x3** will be elapsed.

During this period, depending on the air consumption, the pressure may fall below **P05 Start Pressure**.

In most applications, it is required that the pressure never falls below the **P05 Start Pressure** limit.

In order to prevent this unwanted situation, the unit offers 3 different operating modes selected through program parameter **P45**. The unit calculates dynamically the **restart pressure (Pi)**

**P45 = 0** → No special care taken. **Pi = P05**.

**P45 = 1** → When the compressor is loaded, if the pressure is below **P05 Start Pressure**, then the **Restart Pressure (Pi)** is incremented by 0.1 bar.

When the compressor is loaded, if the pressure is above **P05 Start Pressure**, then the **Restart Pressure (Pi)** is decremented by 0.1 bar. Thus the unit tries to load at exactly **P05 Start Pressure**.

**P45 = 2** → When the compressor reaches P04 Stop Pressure, the unit measures the air consumption during 8 seconds, then calculates the **Restart Pressure (Pi)** again.



**At the end of P26 Unload Timer, if the pressure is above P05 Start Pressure and below Pi Restart Pressure, then the motor will continue to run unloaded.**

## 6.6. ALARM HISTORY

The unit keeps the list of 9 most recent alarm records.

A new occurring alarm will appear at the top of the list.

The alarm list may be visualized on the screen or read through Modbus.

The alarm list is kept in a non-volatile memory and is not affected by power failures.



The alarm will be added to the list only if it is different from the previous alarm or the motor has run at least 6 minutes after its previous occurrence.

In order to visualize the latest alarm in the history press MENU  button until

**Ah 1** (alarm history 1) comes to the display.

To visualize previous alarms use RUN  and STOP  pushbuttons.



**When the alarm history is scrolled the STOP  button is always active and stops the compressor. However the RUN  button is not active and does not run the compressor. To scroll the alarm history when the compressor is running please use only the RUN  button.**

## 7. DIGITAL INPUTS

The unit offers 4 user configurable digital inputs.

The characteristics of these inputs are configured through parameters P73 to P76.

The configuration record consists on 3 parts. The programmed value is the sum of these 3 parts.



**Configuration = part\_1 + part\_2 + part\_3**

### **Part 1 = input fault code:**

This part determines which fault is generated from this input. The complete fault code list is given in chapter 5.

### **Part 2 = input switch type (NO or NC)**

NO (normally open) = 256

NC (normally closed) = 0

### **Part 3 = input detection delay**

0.1sec delay = 0

0.5sec delay = 512

2.0sec delay = 1024

5.0sec delay = 1536

### **Example 1:**

In order to adjust input 2 as EMERGENCY STOP, NC switch and 0.1sec delay:

Part\_1 = 18 (refer chapter 5)

Part\_2 = 0 (NC switch)

Part\_3 = 0 (0.1 sec)

P74 (Input\_2 configuration) = 18+0+0 = **18**

### **Example 2:**

In order to adjust input 4 as REMOTE START, NO switch, 2.0sec delay:

Part\_1 = 200 (refer chapter 5)

Part\_2 = 256 (NO kontak)

Part\_3 = 1024 (2.0 sn)

P76 (Input\_4 configuration) = 200+256+1024 = **1480**

## 8. RELAY OUTPUTS

The unit provides 5 relay outputs. 4 of them have fixed function, while RL5 has selectable function.

Relays with fixed function:

**RL1** = LINE relay

**RL2** = DELTA relay

**RL3** = STAR relay

**RL4** = LOAD relay

**RL5** can be programmed for below functions through parameter **P40**:

RELAY	FUNCTION	DESCRIPTION
0	ALARM	RL5 operates if alarm exists, releases otherwise.
1	FAN	If the air end temperature equals or greater than P41, then RL5 is on. If the air end temperature is lower than (P41-P42), then RL5 is off.
2	LOAD	RL5 = RL4
3	NO LOAD	RL5 = opposite of RL4
4	MOTOR RUNNING	RL5 operates if the main motor runs, releases otherwise.
5	MOTOR STOPPED	RL5 operates if the main motor is stopped, releases otherwise.
6	FLAŞÖR RÖLE	Released during timer P41 Active during timer P42 .

## 9. PROGRAMMING

### 9.1. INTRODUCTION TO PROGRAMMING



The program menu can be entered only when the compressor is in STOP mode.

The entry to programming menu is protected by a 2 level password system. The program parameter set and password levels may differ following compressor manufacturers. This documents describes the parameter set as available ex-works.









#### Factory set values:

Low level password = 386

High level password = 741

#### To enter programming menu:

- When the compressor is in STOP mode, hold pressed MENU  and STOP  buttons for 3 seconds.



- The upper display will show *U5r* . Enter the password using RUN  and STOP  buttons and press MENU  button. For fast increment/decrement, hold pressed RUN  and STOP  buttons.





#### To exit programming menu:

- Hold pressed the MENU  button for 3 seconds.

#### 7Modifying program parameters:

- When programming menu is entered the upper display will show the program number and the lower display will show *SEL* .

- Select parameter number with RUN  and STOP  buttons.

- Display parameter value by pressing the MENU  button. Adjust the parameter with RUN  and STOP  buttons and return to parameter number selection by pressing the MENU  button.



If no key is pressed, the display will return to normal mode after 1 minute.

## 9.2. PARAMETER LIST



Some parameters given in this list may not appear on device display.

No	Description	Adjustment Range	Factory set
P01	Pressure Control	0: Analog transducer 1: Pressure Switch If this parameter is set to 1 then P02 ... P06 parameters are not displayed.	0
P02	Top Range of Pressure Transducer	4.2 ... 99.9	15.0 bar
P03	High Pressure Alarm	(P02-0.5) ... (P04+0.5)	8.5 bar
P04	Stop Pressure	(P03-0.2) ... (P05+0.2)	7.3 bar
P05	Start Pressure	3 ... (P04-0.2)	6.5 bar
P06	Offset Pressure Transducer	-2 ... +2	0 bar
P07	Top range temperature probe	(P08+2) ... 130	130 °C
P08	High air end temperature Alarm	(P09+2) ... (P07-2)	108 °C
P09	High air end temperature Warning	(P10+2) ... (P08-2)	103 °C
P10	Low air end temperature Alarm	-10 ... (P09-2)	0 °C
P11	Offset value air end temperature	-10 ... +10	0 °C
P12	Motor PTC Enable	0: Disable 1: Enable If this parameter is set to 1, then when the resistance measured at the Motor PTC input is above 2000 ohms this will generate an <b>A09 Motor PTC high temperature</b> alarm.	0



No	Description	Adjustment Range	Factory set
P13	Automatic Restart	0:Disable (the unit will power-up always in STOP mode) 1: Enable (the unit will power-up with the same mode as the power-down instant)	0
P14	Temperature for Pressure Compensation	0 ... (P09) While the air end temperature is below this limit, instead of P04 Stop Pressure, $P05+(P04-P05)/4$ value is used. Thus the compressor stops before reaching Stop Pressure .	0 °C
P15	Delay Between Relays	20 ... 250	200ms
P16	Voltage Unbalance Ratio	0 ...20	5 %
P17	Temp. 2 Sensor operation mode	0:Disable 1:Absolute temperature 2:Differential temperature If this parameter is set to 0, the P18, P19, P20 and P22 parameters will not be displayed.	0
P18	Top range Temp. 2 Sensor	$(P19+2) \dots 200$	130 °C
P19	Temp. 2 Sensor High Limit (Delta Alarm Limit)	$(P20+2) \dots (P18-2)$ (Temperature differential alarm Limit)	110 °C
P20	Low Alarm/Delta Warning Temp. 2	$-40 \dots (P19-2)$ (Temperature differential warning Limit)	-10 °C
P21	Alarm/Warning Duration time	1 ... 600	10 sec
P22	Offset value Temp. 2 Sensor	-10:+10	0 °C
P23	Star Timer	2 ... 20	7 sec
P24	Star /Delta transition Timer	10 ... 50	35 ms
P25	Timer before loading	1 ... 120	1 sec
P26	unload timer	0 ... 10	2 min

No	Description	Adjustment Range	Factory set
P27	Unload timer fixed or variable	<b>0:</b> Fixed <b>1:</b> Variable <b>If set to 1:</b> If the stop duration is more than the unload run duration, the unload timer is reduced by 1 minute at each run, until an absolute minimum of 2 minutes.	0
P28	Safety Timer	1 ... 240 Refer to chapter 4 for this parameter.	30 sec
P29	Service A Period	0 ... 32767 If this parameter is set to <b>0</b> , then no service A warning is given.	2000 hours
P30	Service B Period	0 ... 32767 If this parameter is set to <b>0</b> , then no service B warning is given.	4000 hours
P31	Service C Period	0 ... 32767 If this parameter is set to <b>0</b> , then no service C warning is given.	6000 hours
P32	Service D Period	0 ... 32767 If this parameter is set to <b>0</b> , then no service D warning is given.	14000 hours
P33	Service E Period	0 ... 32767 If this parameter is set to <b>0</b> , then no service E warning is given.	20000 hours
P34	Display Extra sensors	<b>0:</b> Disable <b>1:</b> Enable	1
P35	Low level password	0 ... 999	386
P36	High level password	0 ... 999	741
P37	Maximum Starts per Hour	6 ... 60	20
P38	Low Voltage Alarm Enable	<b>0:</b> Disable <b>1:</b> Enable If this parameter is set to <b>0</b> , the P39 parameter will not be displayed.	1
P39	Low Voltage Alarm Value	200 ... 600	360 V-AC

No	Description	Adjustment Range	Factory set
P40	RL5 function selection	<b>0:</b> Alarm <b>1:</b> Fan <b>2:</b> Load <b>3:</b> No load <b>4:</b> Motor run <b>5:</b> Motor stopped  Refer chapter 8 for more details.	2
P41	Fan On Temperature (RL5)	30 ... (P09-2) Refer chapter 8 for more details.	85 °C
P42	Delta T Fan Off Temperature (RL5)	5 ... 15 Refer chapter 8 for more details.	10 °C
P43	Reserved	-	0
P44	Reserved	-	0
P45	Pressure loss preventing method	<b>0:</b> standard operation <b>1:</b> step increase/decrease <b>2:</b> dynamic calculation	0
P46	Reserved	-	0
P47	Reserved	-	0
P48	Connection topology	<b>1:</b> 1 phase <b>2:</b> 2 phases <b>3:</b> 3 phases	3
P49	Phase L1 calibration	1 ...32767	1186
P50	Phase L2 calibration	1 ... 32767	1186
P51	Phase L3 calibration	1 ... 32767	1186
P52	Low Frequency Alarm Enable	<b>0:</b> Disable <b>1:</b> Enable If this parameter is set to <b>0</b> , the P53 parameter will not be displayed.	1
P53	Low Frequency Alarm Limit	10.0 ... 60.0 Hz	48.0 Hz
P54	High Frequency Alarm Enable	<b>0:</b> Disable <b>1:</b> Enable If this parameter is set to <b>0</b> , the P55 parameter will not be displayed.	1

No	Description	Adjustment Range	Factory set
P55	High Frequency Alarm Value	60.0 ... 990.0 Hz	62.0 Hz
P56	Frequency display	0: Disable 1: Enable	1
P57	Phase L1 voltage display	0:Disable 1:Enable	0
P58	Phase L2 voltage display	0:Disable 1:Enable	0
P59	Phase L3 voltage display	0:Disable 1:Enable	0
P60	Phase L1-L2 voltage display	0:Disable 1:Enable	1
P61	Phase L2-L3 voltage display	0:Disable 1:Enable	1
P62	Phase L3-L1 voltage display	0:Disable 1:Enable	1
P63	MODBUS enable	0: Disable 1: Enable	1
P64	Master/Slave MODBUS	0: Slave 1: Master	0
P65	MODBUS node address	1: Starts multiple controller opr. 2 ... 254: Modbus address	240
P66	Slave Start Timer (Multiple controller operation)	1..999 sec.	180 sec
P67	Master Change Period (Multiple operation)	1..999 hours	100 hours
P68	Serial Number Low Word	0 ... 65535	10
P69	Serial Number High Word	0 ... 65535	10
P70	High Voltage Alarm Enable	0: Disable 1: Enable If this parameter is set to 0, the P71 parameter will not be displayed.	1
P71	High Voltage Alarm Limit	200 ... 650 V	445
P72	Phase Order Check Enable	0: Disable 1: Enable	1

No	Description	Adjustment Range	Factory set
<b>P73</b>	Input1 configuration register	0 ... 2047 Refer chapter 7 for more details.	18
<b>P74</b>	Input 2 configuration register	0 ... 2047 Refer chapter 7 for more details.	28+512=540
<b>P75</b>	Input 3configuration register	0 ... 2047 Refer chapter 7 for more details.	8+512=520
<b>P76</b>	Input 4configuration register	0 ... 2047 Refer chapter 7 for more details.	16+256+=1808
<b>P77</b>	Pressure 2 Input Configuration	<b>0:</b> Disabled <b>1:</b> Pressure switch <b>2:</b> Analog transducer If this parameter is set to <b>0</b> or <b>1</b> , parameters P78 ... P82 will not be displayed.	0
<b>P78</b>	Top range pressure 2 transducer	4.2 ... 99.9 Bar	15.0 bar
<b>P79</b>	High Pressure Sensor 2 Alarm Limit	3.7 ... (P78-0.5)	8.8 bar
<b>P80</b>	Differential pressure alarm limit (press1 – press2)	-10.0 ... +10.0	0.5 bar
<b>P81</b>	Differential pressure alarm delay	1 ... 600	10 sec
<b>P82</b>	Offset pressure transducer 2	-2:+2	0 bar

No	Description	Adjustment Range	Factory set
P83	Pressure sensor-2 low pressure alarm limit (if adjusted to 0.0 then no alarm is given)	0.. (P79-0.5)	0
P84	Reserved	-	0
P85	Reserved	-	0
P86	Reserved	-	0
P87	Reserved	-	0
P88	Service security selection	<p><b>0:</b> Service request gives warning only</p> <p><b>1:</b>Service request stops the compressor as explained in chapter_5.</p>	0
P88	Reserved	-	0
P89	Variable Hour counting method	<p><b>0:</b> Fixed hour counting coefficient</p> <p><b>1:</b> Variable hour counting method</p> <p>Refer chapter 6.3 for more details.</p>	0
P90	Pressure Dot Display	<p><b>0:</b> Enable</p> <p><b>1:</b> Disable</p> <p>If this parameter is set to <b>0</b>, the pressure is displayed in xx.x format. This format is useful for display in <b>bars</b>.</p> <p>If this parameter is set to <b>1</b>, the pressure is displayed in xxx format. This format is useful for display in <b>psi</b>.</p>	0

# 10. MODBUS COMMUNICATION

## 10.1. DESCRIPTION

The unit offers serial data communication port allowing it to be integrated in automation systems.

The serial port works with logic levels. With special adapters, it can be converted to RS-232 or RS-485 standards.

### The MODBUS properties of the unit are:

- Data transfer mode: RTU
- Serial data: 9600 bps, 8 bit data, no parity, 1 bit stop
- Supported functions:
  - Function 3 (Read multiple registers, max 120 registers)
  - Function 6 (Write single register)
  - Function 10 (Write multiple registers, max 32 registers)
- The answer to an incoming message is sent with a minimum of 4.3ms delay after message reception.

Each register consists of 2 bytes (16 bits). Larger data structure contain multiple registers.

Detailed description about the MODBUS protocol is found in the document “**Modicon Modbus Protocol Reference Guide**”. ( <http://www.modbus.org/specs.php> )

### Data Reading

The function 03 (read multiple registers) will be used for data reading. The MODBUS master will send a query. The answer will be one of the below:

- A response containing the requested data
- An exceptional response indicating a read error.

The maximum number of registers read in one message is 120. If more registers are requested, the unit will send only the first 120 registers.

The query message specifies the starting register and quantity of registers to be read. The message structure is below:

Byte	Description	Value
0	Controller address	1 to 254
1	Function code	3
2	Starting address high	See below the description of available registers
3	Starting address low	
4	Number of registers high	always 0
5	Number of registers low	max 78h (120 decimal)
6	CRC low byte	See below for the checksum calculation
7	CRC high byte	

Here is the sequence to read 16 registers starting from address 20h (32 decimal):  
01 03 00 20 00 10 45 CC (each byte is expressed as 2 hexadecimal characters)

The checksum value in the above message may be used for the verification of checksum calculation algorithm.

The normal response will be:

Byte	Description	Value
0	Controller address	same as in the query
1	Function code	3
2	Data length in <b>bytes (L)</b>	number of registers * 2
3	High byte of 1st register	
4	Low byte of 1st register	
5	High byte of 2nd register	
6	Low byte of 2nd register	
....		
L+1	High byte of the last register	
L+2	Low byte of the last register	
L+3	CRC low byte	See below for the checksum calculation
L+4	CRC high byte	

The exceptional response will be:

Byte	Description	Value
0	Controller address	same as in the query
1	Function code	131 (function code + 128)
2	Exception code	2 (illegal address)
3	CRC low byte	See below for the checksum calculation
4	CRC high byte	

## Data Writing

The function 06 (write single register) or function 10 (write multiple registers) is used for data writing. A maximum of 32 registers can be written at a time.

The MODBUS master will send a query containing data to be written. The answer will be one of the below:

- A normal response confirming successful write,
- An exceptional response indicating a write error.

Only some of the available registers are authorized to be written. An attempt to write a write protected register will result to the exceptional response.

The query message specifies the register address and data. The message structure is below:

Byte	Description	Value
0	Controller address	1 to 254
1	Function code	6
2	Register address high	See below the description of available registers
3	Register address low	
4	Data high byte	
5	Data low byte	
6	CRC low byte	See below for the checksum calculation
7	CRC high byte	



Here is the sequence to write the value 0010h to the register 40h (64 decimal):  
01 06 00 40 00 10 89 D2 (each byte is expressed as 2 hexadecimal characters)

The checksum value in the above message may be used for the verification of checksum calculation algorithm

The normal response will be the same as the query:

Byte	Description	Value
0	Controller address	1 to 254
1	Function code	6
2	Register address high	See below the description of available registers
3	Register address low	
4	Data high byte	
5	Data low byte	
6	CRC low byte	See below for the checksum calculation
7	CRC high byte	

The exceptional response will be:

Byte	Description	Value
0	Controller address	same as in the query
1	Function code	134 (function code + 128)
2	Exception code	2 (illegal address) or 10 (write protection)
3	CRC low byte	See below for the checksum calculation
4	CRC high byte	

## CRC calculation

Here is a procedure for generating a CRC:

- 1) Load a 16-bit register with FFFF hex (all 1's). Call this the CRC register.
- 2) Exclusive OR the first 8-bit byte of the message (the function code byte) with the low-order byte of the 16-bit CRC register, putting the result in the CRC register.
- 3) Shift the CRC register one bit to the right (toward the LSB), zero-filling the MSB. Extract and examine the LSB. The LSB is the least significant bit of the CRC **before** the shift operation.
- 4) If the LSB is 1: Exclusive OR the CRC register with the polynomial value A001 hex.
- 5) Repeat Steps 3 and 4 until 8 shifts have been performed. Thus, a complete 8-bit byte will be processed.
- 6) Repeat Steps 2 through 5 for the next 8-bit byte of the message. Continue doing this until all bytes have been processed.
- 7) The final contents of the CRC register is the CRC value.
- 8) Place the CRC into the message such that the low byte is transmitted first. The algorithm should give the correct CRC for below messages:

```
01 03 00 20 00 10 45 CC
01 06 00 40 00 10 89 D2
```

**Error codes**

Only 3 error codes are used:

01: illegal function code

02: illegal address

10: write protection (attempt to write a read\_only register)

**Data types**

Each register consists of 16 bits (2 bytes)

If the data type is a byte, only the low byte will contain valid data. High byte is don't care.

For data type longer than 16 bits, consecutive registers are used. The least significant register comes first.

## 10.2. MODBUS REGISTER LIST

CONTROLLER REGISTERS						
ADDR.	NAME	DESCRIPTION	LENG.	R/W	TYPE	MUL.
40001	Frequency		16 BIT	R-O	unsigned word	0.1
40002	Phase L1 Voltage		16 BIT	R-O	unsigned word	1
40003	Phase L2 Voltage		16 BIT	R-O	unsigned word	1
40004	Phase L3 Voltage		16 BIT	R-O	unsigned word	1
40005	Phase L1-L2 Voltage		16 BIT	R-O	unsigned word	1
40006	Phase L2-L3 Voltage		16 BIT	R-O	unsigned word	1
40007	Phase L3-L1 Voltage		16 BIT	R-O	unsigned word	1
40008	Pressure	Pressure Value	16 BIT	R-O	unsigned word	0.1
40009	Air end temperature	Temperature Value	16 BIT	R-O	signed word	1
40010	Motor PTC ohm	read in ohms	16 BIT	R-O	signed word	1
40011	Temperature 2	Measured from Sensor 2	16 BIT	R-O	signed word	1
40012	Pressure 2	Measured from Sensor 2	16 BIT	R-O	unsigned word	0.1
40013	Service A Counter	remaining time to service A	32 BIT	R-O	signed long	0.1
40014						
40015	Service B Counter	remaining time to service B	32 BIT	R-O	signed long	0.1
40016						
40017	Service C Counter	remaining time to service C	32 BIT	R-O	signed long	0.1
40018						
40019	Service D Counter	remaining time to service D	32 BIT	R-O	signed long	0.1
40020						
40021	Service E Counter	remaining time to service E	32 BIT	R-O	signed long	0.1
40022						
40023	Total Working Hour	Total controller time (LOAD + UNLOAD + STOP)	32 BIT	R-O	unsigned long	0.1
40024						
40025	Total Engine Hour	Total Engine working hour(LOAD+UNLOAD)	32 BIT	R-O	unsigned long	0.1
40026						
40027	Total Load Hour	Total Engine loaded hour(LOAD)	32 BIT	R-O	unsigned long	0.1
40028						
40029	Alarms	alarm bits (see alarm list at chapter 10.3)	32 BIT	R-O	unsigned long	1
40030						
40031	Warnings	warnings bits (see alarm list at chapter 10.3)	16 BIT	R-O	unsigned word	1
40032	Service requests	maintenance register (see list at chapter 10.3)	16 BIT	R-O	unsigned word	1

<b>CONTROLLER REGISTERS</b>						
ADDR.	NAME	DESCRIPTION	LENG.	R/W	TYPE	MUL.
40033	Motor Status	Current motor status 0: Compressor in OFF mode 1: Motor star 2: Motor delta (before load) 3: Motor loaded 4: Motor unloaded 5: Motor stopped, compressor in RUN mode	16 BIT	R-O	unsigned word	1
40034	Fault Code	Current alarm or warning or service code	16 BIT	R-O	unsigned word	1
40035	Relay status	Current relay status bits bit 1-3:- bit 4: Line relay bit 5: RL5 (alarm/fan) bit 6: Load relay bit 7: Delta relay bit 8: Star relay bit 9-16: -	16 BIT	R-O	unsigned word	1
40036	-	-	16 BIT	R-O	unsigned word	1
40037	Alarm 1	Alarm 1 in alarm history	16 BIT	R-O	unsigned word	1
40038	Alarm 2	Alarm 2 in alarm history	16 BIT	R-O	unsigned word	1
40039	Alarm 3	Alarm 3 in alarm history	16 BIT	R-O	unsigned word	1
40040	Alarm 4	Alarm 4 in alarm history	16 BIT	R-O	unsigned word	1
40041	Alarm 5	Alarm 5 in alarm history	16 BIT	R-O	unsigned word	1
40042	Alarm 6	Alarm 6 in alarm history	16 BIT	R-O	unsigned word	1
40043	Alarm 7	Alarm 7 in alarm history	16 BIT	R-O	unsigned word	1
40044	Alarm 8	Alarm 8 in alarm history	16 BIT	R-O	unsigned word	1
40045	Alarm 9	Alarm 9 in alarm history	16 BIT	R-O	unsigned word	1
40046	Connection topology	1:Single phase, 2:bi-phase 3: three phase	16 BIT	R-O	unsigned word	1
40047 - 40128	reserved	-	16 BIT	R-O	unsigned word	1

<b>PROGRAM PARAMETERS</b>						
ADDR.	NAME	DESCRIPTION	LENG.	R/W	TYPE	MUL.
40129	P01	See chapter 9.2	16 BIT	R/W	unsigned word	1
40130	P02	See chapter 9.2	16 BIT	R/W	unsigned word	0.1
40131	P03	See chapter 9.2	16 BIT	R/W	unsigned word	0.1
40132	P04	See chapter 9.2	16 BIT	R/W	unsigned word	0.1
40133	P05	See chapter 9.2	16 BIT	R/W	unsigned word	0.1
40134	P06	See chapter 9.2	16 BIT	R/W	signed word	0.1
40135	P07	See chapter 9.2	16 BIT	R/W	signed word	1
40136	P08	See chapter 9.2	16 BIT	R/W	signed word	1
40137	P09	See chapter 9.2	16 BIT	R/W	signed word	1
40138	P10	See chapter 9.2	16 BIT	R/W	signed word	1

<b>PROGRAM PARAMETERS</b>						
ADDR.	NAME	DESCRIPTION	LENG.	R/W	TYPE	MUL.
40139	P11	See chapter 9.2	16 BIT	R/W	signed word	1
40140	P12	See chapter 9.2	16 BIT	R/W	signed word	1
40141	P13	See chapter 9.2	16 BIT	R/W	signed word	1
40142	P14	See chapter 9.2	16 BIT	R/W	signed word	1
40143	P15	See chapter 9.2	16 BIT	R/W	signed word	1
40144	P16	See chapter 9.2	16 BIT	R/W	signed word	1
40145	P17	See chapter 9.2	16 BIT	R/W	signed word	1
40146	P18	See chapter 9.2	16 BIT	R/W	signed word	1
40147	P19	See chapter 9.2	16 BIT	R/W	signed word	1
40148	P20	See chapter 9.2	16 BIT	R/W	signed word	1
40149	P21	See chapter 9.2	16 BIT	R/W	signed word	1
40150	P22	See chapter 9.2	16 BIT	R/W	signed word	1
40151	P23	See chapter 9.2	16 BIT	R/W	unsigned word	1
40152	P24	See chapter 9.2	16 BIT	R/W	unsigned word	1
40153	P25	See chapter 9.2	16 BIT	R/W	unsigned word	1
40154	P26	See chapter 9.2	16 BIT	R/W	unsigned word	1
40155	P27	See chapter 9.2	16 BIT	R/W	unsigned word	1
40156	P28	See chapter 9.2	16 BIT	R/W	unsigned word	1
40157	P29	See chapter 9.2	16 BIT	R/W	unsigned word	1
40158	P30	See chapter 9.2	16 BIT	R/W	unsigned word	1
40159	P31	See chapter 9.2	16 BIT	R/W	unsigned word	1
40160	P32	See chapter 9.2	16 BIT	R/W	unsigned word	1
40161	P33	See chapter 9.2	16 BIT	R/W	unsigned word	1
40162	P34	See chapter 9.2	16 BIT	R/W	unsigned word	1
40163	P35	See chapter 9.2	16 BIT	R/W	unsigned word	1
40164	P36	See chapter 9.2	16 BIT	R/W	unsigned word	1
40165	P37	See chapter 9.2	16 BIT	R/W	unsigned word	1
40166	P38	See chapter 9.2	16 BIT	R/W	unsigned word	1
40167	P39	See chapter 9.2	16 BIT	R/W	unsigned word	1
40168	P40	See chapter 9.2	16 BIT	R/W	unsigned word	1
40169	P41	See chapter 9.2	16 BIT	R/W	signed word	1
40170	P42	See chapter 9.2	16 BIT	R/W	signed word	1
40171	P43	See chapter 9.2	16 BIT	R/W	unsigned word	1
40172	P44	See chapter 9.2	16 BIT	R/W	unsigned word	1
40173	P45	See chapter 9.2	16 BIT	R/W	unsigned word	0.1
40174	P46	See chapter 9.2	16 BIT	R/W	unsigned word	0.1
40175	P47	See chapter 9.2	16 BIT	R/W	unsigned word	0.1
40176	P48	See chapter 9.2	16 BIT	R/W	unsigned word	0.1
40177	P49	See chapter 9.2	16 BIT	R/W	unsigned word	1
40178	P50	See chapter 9.2	16 BIT	R/W	unsigned word	1
40179	P51	See chapter 9.2	16 BIT	R/W	unsigned word	1

<b>PROGRAM PARAMETERS</b>						
ADDR.	NAME	DESCRIPTION	LENG.	R/W	TYPE	MUL.
40180	P52	See chapter 9.2	16 BIT	R/W	unsigned word	1
40181	P53	See chapter 9.2	16 BIT	R/W	unsigned word	0.1
40182	P54	See chapter 9.2	16 BIT	R/W	unsigned word	1
40183	P55	See chapter 9.2	16 BIT	R/W	unsigned word	0.1
40184	P56	See chapter 9.2	16 BIT	R/W	unsigned word	1
40185	P57	See chapter 9.2	16 BIT	R/W	unsigned word	1
40186	P58	See chapter 9.2	16 BIT	R/W	unsigned word	1
40187	P59	See chapter 9.2	16 BIT	R/W	unsigned word	1
40188	P60	See chapter 9.2	16 BIT	R/W	unsigned word	1
40189	P61	See chapter 9.2	16 BIT	R/W	unsigned word	1
40190	P62	See chapter 9.2	16 BIT	R/W	unsigned word	1
40191	P63	See chapter 9.2	16 BIT	R/W	unsigned word	1
40192	P64	See chapter 9.2	16 BIT	R/W	unsigned word	1
40193	P65	See chapter 9.2	16 BIT	R/W	unsigned word	1
40194	P66	See chapter 9.2	16 BIT	R/W	unsigned word	1
40195	P67	See chapter 9.2	16 BIT	R/W	unsigned word	1
40196	P68	See chapter 9.2	16 BIT	R/W	unsigned word	1
40197	P69	See chapter 9.2	16 BIT	R/W	unsigned word	1
40198	P70	See chapter 9.2	16 BIT	R/W	unsigned word	1
40199	P71	See chapter 9.2	16 BIT	R/W	unsigned word	1
40200	P72	See chapter 9.2	16 BIT	R/W	unsigned word	1
40201	P73	See chapter 9.2	16 BIT	R/W	unsigned word	1
40202	P74	See chapter 9.2	16 BIT	R/W	unsigned word	1
40203	P75	See chapter 9.2	16 BIT	R/W	unsigned word	1
40204	P76	See chapter 9.2	16 BIT	R/W	unsigned word	1
40205	P77	See chapter 9.2	16 BIT	R/W	unsigned word	1
40206	P78	See chapter 9.2	16 BIT	R/W	unsigned word	0.1
40207	P79	See chapter 9.2	16 BIT	R/W	unsigned word	0.1
40208	P80	See chapter 9.2	16 BIT	R/W	unsigned word	0.1
40209	P81	See chapter 9.2	16 BIT	R/W	unsigned word	1
40210	P82	See chapter 9.2	16 BIT	R/W	unsigned word	0.1
40211	P83	See chapter 9.2	16 BIT	R/W	unsigned word	1
40212	P84	See chapter 9.2	16 BIT	R/W	unsigned word	0.1
40213	P85	See chapter 9.2	16 BIT	R/W	unsigned word	0.1
40214	P86	See chapter 9.2	16 BIT	R/W	unsigned word	0.1
40215	P87	See chapter 9.2	16 BIT	R/W	unsigned word	0.1
40216	P88	See chapter 9.2	16 BIT	R/W	unsigned word	0.1
40217	P89	See chapter 9.2	16 BIT	R/W	unsigned word	1
40218	P90	See chapter 9.2	16 BIT	R/W	unsigned word	1
40219 - 40256	reserved	reserved registers	16 BIT	R/W	unsigned word	1

<b>SENSOR GRAPHS</b>						
40385 - 40416	PRESS_SENSOR GRAPH [32]	Pressure Sensor (mA - Bar)	32*16 BIT	R-O	unsigned word	1
40417 - 40448	TEMPERATURE SENSOR GRAPH [32]	Temperature Sensor(Ohm - °C)	32*16 BIT	R-O	signed word	1
40449 - 40480	MOTOR PTC SENSOR GRAPH [32]	Motor PTC Temperature Sensor(Ohm - °C)	32*16 BIT	R-O	signed word	1
40481 - 40512	TEMPERATURE 2 SENSOR GRAPH [32]	Temperature Sensor 2 (Ohm - °C)	32*16 BIT	R-O	signed word	1
40513 - 40544	PRESSURE 2 SENSOR GRAPH [32]	Pressure Sensor 2 Graph (mA - Bar)	32*16 BIT	R-O	unsigned word	1

<b>COMMANDS</b>						
40769	C01	Reserved register	16 BIT	W-O	unsigned word	1
40770	C02	Return to Factory (value = 0xAA55)	16 BIT	W-O	unsigned word	1
40771	C03	Reset Counter (value = Counter(1-8))	16 BIT	W-O	unsigned word	1
40772	C04	LOCK KEY (Value = KEY CODE)	16 BIT	W-O	unsigned word	1
40773 - 40800	Reserved	-	16 BIT	W-O	unsigned word	1
40801	Set service 1	Time to service A (low 2 bytes)	16 BIT	W-O	unsigned word	1
40802	Set service 2	Time to service A (high 2 bytes)	16 BIT	W-O	unsigned word	1
40803	Set service 3	Time to service B (low 2 bytes)	16 BIT	W-O	unsigned word	1
40804	Set service 4	Time to service B (high 2 bytes)	16 BIT	W-O	unsigned word	1
40805	Set service 5	Time to service C (low 2 bytes)	16 BIT	W-O	unsigned word	1
40806	Set service 6	Time to service C (high 2 bytes)	16 BIT	W-O	unsigned word	1
40807	Set service 7	Time to service D (low 2 bytes)	16 BIT	W-O	unsigned word	1
40808	Set service 8	Time to service D (high 2 bytes)	16 BIT	W-O	unsigned word	1
40809	Set service 9	Time to service E (low 2 bytes)	16 BIT	W-O	unsigned word	1
40810	Set service 10	Time to service E (high 2 bytes)	16 BIT	W-O	unsigned word	1
40811	Set service 11	<b>LOADED+UNLOADED+STOP</b> time (low 2 bytes)	16 BIT	W-O	unsigned word	1
40812	Set service 12	<b>LOADED+UNLOADED+STOP</b> time (high 2 bytes)	16 BIT	W-O	unsigned word	1
40813	Set Service 13	Engine run hours (low 2 bytes)	16 BIT	W-O	unsigned word	1
40814	Set Service 14	Engine run hours (high 2 bytes)	16 BIT	W-O	unsigned word	1
40815	Set Service 15	Load run hours (low 2 bytes)	16 BIT	W-O	unsigned word	1
40816	Set Service 16	Load run hours (high 2 bytes)	16 BIT	W-O	unsigned word	1
40817	C05	Alarm history reset (Value = 0xAA55 hex)	16 BIT	W-O	unsigned word	1



## 10.3. ALARMS-WARNINGS-SERVICE REQUESTS

The ALARM record is 32 bits. Each bit indicates the existence of an alarm.

<b>BIT NO:</b>	<b>DESCRIPTION</b>
1	Low Voltage Alarm
2	High Voltage Alarm
3	Low Frequency Alarm
4	High Frequency Alarm
5	Thermal Motor Switch Open
6	Thermal Fan Switch Open
7	High Temperature Alarm
8	Temperature Sensor Fail
9	Low Temperature Alarm
10	Security Pressure Switch Open
11	High Pressure Alarm
12	Pressure Transducer Fail
13	Emergency Stop
14	-
15	Motor PTC Sensor Fail
16	Motor PTC High Temperature Alarm
17	Motor PTC Low Temperature Alarm
18	Phase Sequence Fail Alarm
19	Air Filter Clogged
20	Temperature Sensor 2 Fail
21	High Temperature 2 Alarm
22	Low Temperature 2 Alarm
23	Pressure Transducer 2 Fail
24	High Pressure 2 Alarm
25	Differential Pressure Alarm
26-32	-

The warning register is 16 bits. Each bit indicates the existence of a warning.

<b>BIT NO:</b>	<b>DESCRIPTION</b>
1	Remote Stop
2	Remote Start
3	Parameter out of limits
4	High Temperature
5	No Stop since 1 Hour
6	Start waits separator pressure drop
7	Differential temperature
8-16	-

The service request register is 16 bits. Each bit indicates the existence of a service request.

<b>BIT NO:</b>	<b>DESCRIPTION</b>
1	Service A requested
2	Service B requested
3	Service C requested
4	Service D requested
5	Service E requested
6-16	-

# 11. MULTIPLE CONTROLLER OPERATION

The multiple controller operation is designed for installations where more than one compressor have to operate in parallel.

The multiple controller operation allows energy efficiency by running only the necessary number of compressors in case of low air consumption. It performs equal aging of compressors as well.

A maximum of 8 compressors can operate in parallel.

The multiple compressor operation is performed through the serial port of the unit. Controllers will communicate through a common **RS-485 bus** using **RS-485 converters**.

The multiple compressor operation is enabled by assigning the **P65 Modbus Address = 1** to one of the controllers. **Following numbers** must be given to other controllers in the same group. No gap is allowed.

If a gap exists, controllers coming after the gap will operate independently.

## Operation:

1. If the communication between units is lost, then controllers will operate independently.
2. The controller with the least engine hours will become the **master** and operate following **P04-P05** parameters. Other compressors will run and stop following their engine hours.
3. If any of the compressors has **P67 Master Change Period** less engine hours than the master controller, then this one becomes the new master.
4. If an alarm occurs at the master controller, then another controller will become master.
5. If the pressure falls below **P05**, the master will run immediately. Other compressors will run with delays of **P66/8**.
6. If at the expiration of **P66** timer, the pressure is above **P05** but below  $(P04+P05)/2$ , then compressors will run with **P66/4** delays.
7. When the pressure approaches **P04**, compressors will stop in their respective order of run hours.

## 12. DECLARATION OF CONFORMITY

The unit conforms to the EU directives

-2006/95/EC (low voltage)

-2004/108/EC (electro-magnetic compatibility)

Norms of reference:

EN 61010 (safety requirements)

EN 61326 (EMC requirements)

The CE mark indicates that this product complies with the European requirements for safety, health environmental and customer protection.

## 13. TECHNICAL SPECIFICATIONS

**Supply Voltage:** 305 – 460 VAC (between IN-COMM and IN-400V terminals)  
175 - 275VAC (between IN-COMM and IN-230V terminals)

**Supply Frequency:** 50 - 60Hz nominal ( $\pm$  %10)

**Power consumption:** < 4 VA

**Measurement Input Range:**

**Voltage:** 20 - 520 V AC (L-L)  
10 - 300 V AC (L-N)

**Frequency:** 30 - 100 Hz

**Accuracy:** **Voltage:** 0.5% + 1 digit

**Frequency:** 0.5% + 1 digit

**Voltage burden:** < 0.1VA per phase

**Relay Outputs:** 5A @ 250V AC

**Digital Inputs:** **Supply:** provided from the unit.

**Active level:** external switch resistance < 3 K-ohms

**Isolation:** opto-isolated, 1000V AC, 1 minute

**Pressure Inputs:** 4-20mA pressure transducer (optional 0-10V transducer)

**Temperature Inputs:** 1000-5000 ohms (KTY or NTC or PTC sensor)  
Heating current < 0.3mA

**Motor PTC input:** gives alarm above 2000 ohms

**Serial Port:** **Signal type:** logic levels (0/5V)  
**Communication:** Modbus RTU  
**Data Rate:** 9600 baud

**Operating Temperature:** -30°C...+80 °C (-22 ... +176 °F)

**Storage Temperature:** -40°C...+80 °C (-40 ... +176 °F)

**Maximum Humidity:** 95% non-condensing

**Degree of Protection:** IP 54 (Front Panel)  
IP 30 (Back panel)

**Enclosure:** Non-flammable, ROHS compliant, ABS/PC (UL94-V0)

**Installation:** Flush mounting with rear retaining plastic brackets

**Dimensions:** 134x107x54mm (WxHxD)

**Panel Cutout:** 116x86mm

**Weight:** 350 gr

**EU Directives Conformity:**

2006/95/EC (low voltage)

2004/108/EC (EMC)

**Norms of reference:**

EN 61010 (safety requirements)

EN 61326 (EMC requirements)